

Prahlad Jani Is A set Of Informations (Code PcPs) . Some Informations (Code PcPs -- water , food and energy cycle) Are Triggered By Unconditioned Thought Expressions (CCP) . Hence Few Body Metabolic Cycles (Water, Food And Energy) of Prahlad Are Showing Lawlessness . Mandel's Law Of Independent Assortment States That Expression of Two or More Than Two Thoughts Are Independent of Each other.

Dr V M Das

Das Nursing Home , Fatehgarh , India
University Of God

Abstract : Starvation is a conditioned phenomenon but despite of starvation if cell lives it is unconditioned phenomenon and it is lawlessness. To understand phenomenon of body structure and function (Both normal and abnormal), we have to understand Basic Building Blocks (B.B.B – Mind – CCP , Code PcPs and CP and Mass -- Fig 1). Life effects are higher thought expressions (activation different Code PcPs – informations) of B.B.Bs. Formations of molecules , atoms and particles are due to lower thought expressions (Thought - CCP – Programming – Code PcPs –Interaction – Effects) . If thought expressions are abnormal it called lawlessness in nature . After certain age (11 years) Prahlad's body transformed to certain changes that are abnormal to us . And it followed Mandel's law of Independent assortment also . These thoughts are fed thoughts and feeding was done in precreation era by the Highest center of the universe . We are set of informations (Code PcPs) . Informations (Code PcPs) never die . The theory predicts that Informations(Code PcPs) could be recreated . Hence dead cell could be made Alive only by Highest center of the universe (Almighty B.B.B)

Keywords – Basic Building Blocks , Mind and Mass , Atomic genetics , Atomic transcription and Translation , Tachyons

Date of Submission: 28-08-2017

Date of acceptance: 08-09-2017

I. Introduction

1.1 Prahlad Jani [1]

Early life[edit]

Born Chunriwala Mataji, Jani grew up in Charada village in Mehsana district.^[1] According to Jani, he left his home in Rajasthan at the age of seven, and went to live in the jungle.^[2]

At the age of 11, Jani underwent a religious experience and became a follower of the Hindu goddess Amba. From that time, he chose to dress as a female devotee of Amba, wearing a red sari-like garment, jewellery and crimson flowers in his shoulder-length hair.^[2] Jani is commonly known as Mataji ("[a manifestation of] The Great Mother"). Jani believes that the goddess provides him a liquid sustenance^[2] or water which drops down through a hole in his palate, allowing him to live without food or drink.^[1]

Since the 1970s, Jani has lived as a hermit in a cave in the rainforest near the Gujarati temple of Ambaji, awakening at 4am each day and spending most of his time meditating.^[2]

Investigations[edit]

Two observational studies of Jani have been conducted, one in 2003 and one in 2010, both involving Dr Sudhir Shah, a neurologist at the Sterling Hospitals in Ahmedabad, India, who had studied people claiming to have exceptional abilities, including other fasters such as Hira Ratan Manek. In both cases the investigators confirmed Jani's ability to survive healthily without food and water during the testing periods, although neither study was submitted to a scientific journal.^[3] When questioned six days into the 2010 experiment, the DRDO spokesperson announced that the study's findings would be "confidential" until results were established,^[4] and a further official press release by the team stated that any inside analysis information may be disclosed only at the discretion of the principal investigator, DIPAS.^[citation needed] Uninvolved doctors and other critics have questioned the validity of the studies^{[2][5][6]} and stated their belief that, although people can survive for days

without food or water, it is not possible to survive for years,^[6] especially since glucose, a substrate critical to brain function, isn't provided.^[7] The veracity of Mataji's claims has also never been independently confirmed with all tests being indigenously conducted.

2003 tests[edit]

In 2003, Dr Sudhir Shah and other physicians at Sterling Hospitals, Ahmedabad, India observed Jani for 10 days. He stayed in a sealed room. Doctors say that he passed no urine or stool during the observation, but that urine appeared to form in the bladder.^[1] A hospital spokesperson said that Jani was physically normal, but noted that a hole in the palate was an abnormal condition.^[1] The fact that Jani's weight dropped slightly during the 10 days has cast some doubt on his claim to go indefinitely without food.^[8]

2010 tests[edit]

From 22 April until 6 May 2010, Prahlad Jani was again observed and tested by Dr Sudhir Shah and a team of 35 researchers from the Indian Defence Institute of Physiology and Allied Sciences (DIPAS), as well as other organizations.^{[2][9][10][11]} The director of DIPAS said that the results of the observations could "tremendously benefit mankind", as well as "soldiers, victims of calamities and astronauts", all of whom may have to survive without food or water for long durations.^[12] The tests were again conducted at Sterling Hospitals.^[13] Professor Anil Gupta of SRISTI,^[14] involved in monitoring the tests, described the team as being "intrigued" by Jani's kriyas apparently allowing him to control his body's physiological functions.^[15]

The team studied Jani with daily clinical examinations, blood tests, and scans. Round-the-clock surveillance was reportedly followed using multiple CCTV cameras and personal observation. The researchers say that Jani was taken out of the sealed room for tests and exposure to sun under continuous video recording.^[16] According to the researchers, Jani's only contact with any form of fluid was said to be during gargling and occasional bathing starting from the 5th day of observation, and the toilet in Jani's room was sealed to test his claim that he did not need to urinate or defecate.^[2]

After fifteen days of observation during which he reportedly did not eat, drink or go to the toilet, all medical tests on Jani were reported as normal^[16] and researchers described him as being in better health than someone half his age.^[2] The doctors reported that although the amount of liquid in Jani's bladder fluctuated and that Jani appeared "able to generate urine in his bladder",^[15] he did not pass urine. Based on Jani's reported levels of leptin and ghrelin, two appetite-related hormones, DRDO researchers posited that Jani may be demonstrating an extreme form of adaptation to starvation and water restriction.^[17] DIPAS stated in 2010 that further studies were planned,^{[18][19]} including investigations into how metabolic waste material is eliminated from Jani's body, from where he gets his energy for sustenance, and how he maintains his hydration status.^[20]

Reactions[edit]

Dr. Michael Van Rooyen, director of the Harvard Humanitarian Initiative, dismissed the observation results as "impossible", observing that the bodies of profoundly malnourished people quickly consume their own body's resources, resulting in liver failure, tachycardia and heart strain. A spokeswoman for the American Dietetic Association stated that, "The bottom line is that even fasting for more than a day can be dangerous. You need food to function."^[5] Nutrition researcher Peter Clifton also disagreed with study results, accusing the research team of "cheating" by allowing Jani to gargle and bathe, and stating that a human of average weight would die after "15 to 20 days" without water.^[6] People who avoid food and water to emulate mystical figures often die.^[6] Sanal Edamaruku characterized the experiment as a farce for allowing Jani to move out of the CCTV cameras' field of view, claiming that video footage showed Jani was allowed to receive devotees and to leave the sealed test room for sunbathing. Edamaruku also said that the gargling and bathing activities were insufficiently monitored. Edamaruku was denied access to the site where the tests were conducted in both 2003 and 2010,^[3] and accuses Jani of having "influential protectors" responsible for denying him permission to inspect the project during its operation, despite having been invited to join the test during a live television broadcast.^[3] The Indian Rationalist Association observed that individuals making similar claims in the past have been exposed as frauds.^[2]

In September 2010, Dr Shah announced that scientists from Austria and Germany had offered to visit India to carry out further research on Jani, and scientists from the United States had also offered to join the research. Jani has expressed interest in cooperating in further investigations.^[21]

DATE	TIME	URINARY BLADDER VOLUME
12/11/2003	12:18	100 cc
13/11/2003	12:18	236 cc
13/11/2003	16:36	236 cc
14/11/2003	10:00	430 cc
14/11/2003	18:59	226 cc
15/11/2003	10:29	301 cc
15/11/2003	17:32	300 cc
16/11/2003	11:22	134 cc
16/11/2003	17:22	221 cc
17/11/2003	11:40	123 cc
17/11/2003	18:19	180 cc
18/11/2003	11:14	62 cc
18/11/2003	17:57	7.2 cc

A screenshot of Dr. Mehta’s data concerning the radiological investigations in the Jani Case shows the fluctuations in his urinary bladder in the week where Jani did not perform his bathing rituals.

For example, the yogi lost some weight during the study and this would be evidence that his claims are wrong, said the head of the Austrian Skeptics Society Dr. Ulrich Berger. Mathematican and head skeptic Berger did more research than James Randi on the case and actually read through the published study and the presentation of Dr. Shah and found that "the daily weight varied between 42 und 38 kilos". So Dr. Berger published as counterevidence that Jani lost 4 kilos from day one to the end of the study.

Daily weight (Varied from 42 kg to 38 kg)

Weiters

findet sich auch ein Foto eines Dokuments, aus dem aufgrund des Datums klar hervorgeht, dass das Gewicht von 38 kg am Ende der Untersuchungsperiode gemessen wurde:

Metabolic Profile			
Procedure Date : 2003-11-26		Imaged On : 2003-11-29	
Name : PRAHLADBHAI JANI MATA	Age : 77yrs	Gender : male	
Profile	Measured	Normal	Deviations
Body Weight (Kgs)	38.66	43 - 54	-5

Die naheliegende Schlussfolgerung

daraus ist, dass Janis Startgewicht 42 kg betrug und er während der 10 Tage ganze 4 kg – also etwa 10% – an Gewicht verloren hat.

What is New Physics or Physics of Mind ?

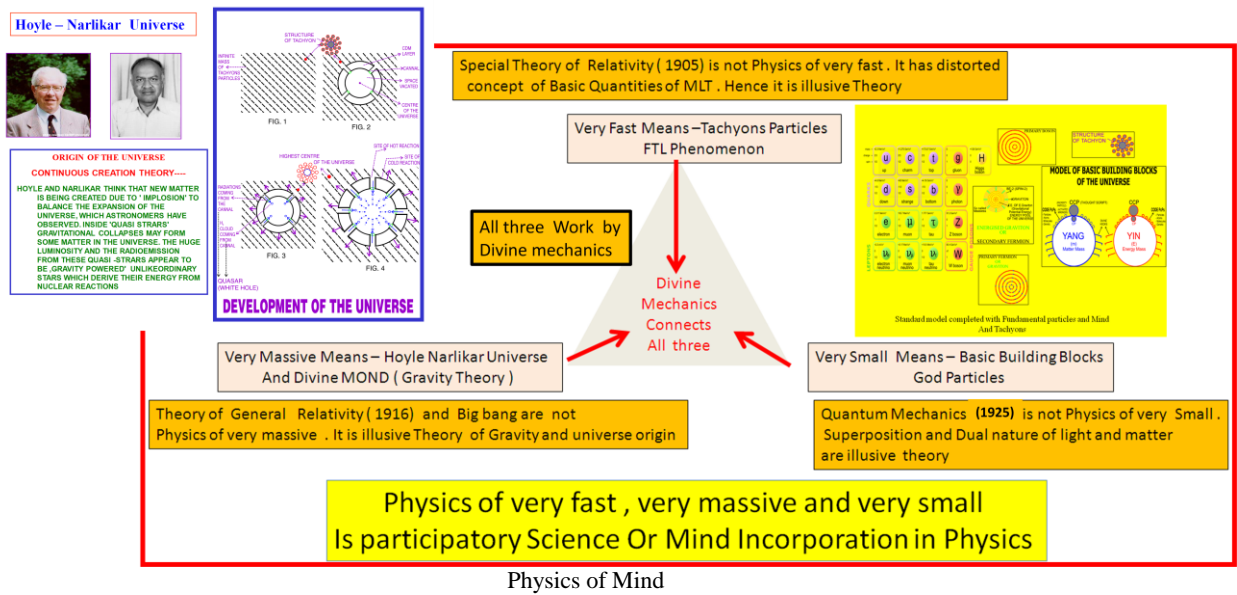

Quantum Consciousness – According to Physicists and Biologist



The nature of consciousness remains deeply mysterious and profoundly important, with existential, medical and spiritual implication. We know what it is like to *be* conscious – to have awareness, a conscious ‘mind’, but who, or what, are ‘we’ who know such things? How is the subjective nature of phenomenal experience – our ‘inner life’ - to be explained in scientific terms? What consciousness actually *is*, and how it comes about remain unknown. The general assumption in modern science and philosophy - the ‘standard model’ - is that consciousness emerges from complex computation among brain neurons, computation whose currency is seen as neuronal firings (‘spikes’) and synaptic transmissions, equated with binary ‘bits’ in digital computing. Consciousness is presumed to ‘emerge’ from complex neuronal computation, and to have arisen during biological evolution as an adaptation of living systems, extrinsic to the makeup of the universe. On the other hand, spiritual and contemplative traditions, and some scientists and philosophers consider consciousness to be intrinsic, ‘woven into the fabric of the universe’. In these views, conscious precursors and Platonic forms preceded biology, existing all along in the fine scale structure of reality.

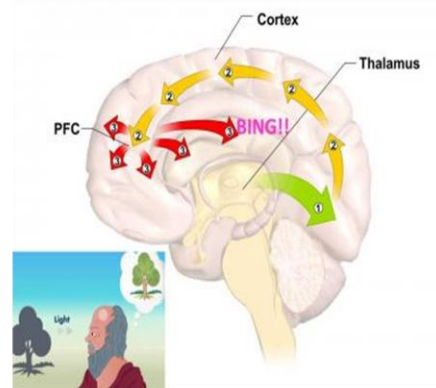
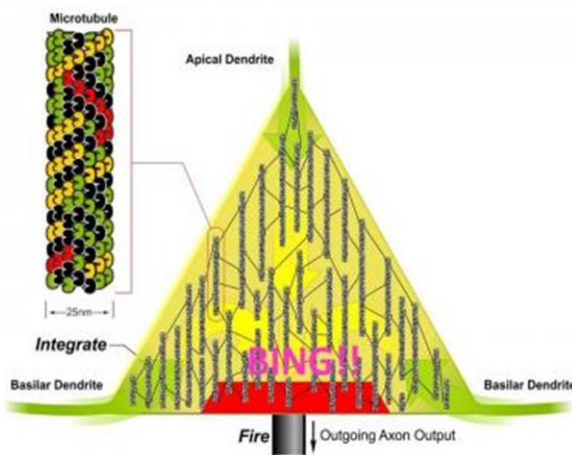

Wrong depiction of visual realization

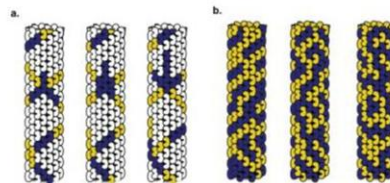
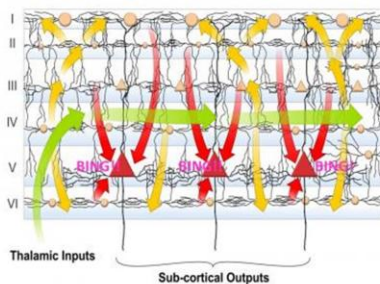

My research involves a theory of consciousness which can bridge these two approaches, a theory developed over the past 20 years with eminent British physicist Sir Roger Penrose. Called ‘orchestrated objective reduction’ (‘Orch OR’), it suggests consciousness arises from quantum vibrations in protein polymers called microtubules inside the brain’s neurons, vibrations which interfere, ‘collapse’ and resonate across scale, control neuronal firings, generate consciousness, and connect ultimately to ‘deeper order’ ripples in spacetime geometry. Consciousness is more like music than computation.

Colleagues Travis Craddock and Jack Tuszyński and I also study how anesthetics act in microtubules to erase consciousness, and with Jay Sanguinetti, John JB Allen and Sterling Cooley, we are studying how transcranial ultrasound (TUS) can be used noninvasively to resonate brain microtubules and treat mental, cognitive and neurological disorders.

Many thanks to my assistant Abi Behar-Montefiore and Ed Xia for maintaining this website.

STUART R. HAMEROFF, MD
 Director, Center for Consciousness Studies
 Professor Emeritus
 Department of Anesthesiology, College of Medicine,
 University of Arizona and Department of Psychology
 Banner – University Medical Center Tucson
 Quantum Consciousness Theorist & Researcher
hameroff@u.arizona.edu

1.2 Mind and Mass Realities [2]

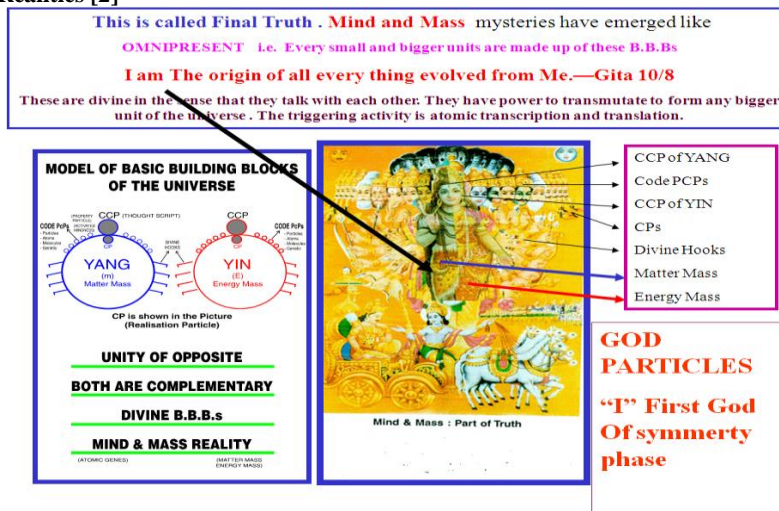

Fig. 1 Divine Mechanics Unit – CCP, CP and information s – Code PcPs with B-Bit – Mass

Atomic genetics is the branch of science where we investigate about fundamental interactions of the universe i.e. atomic transcription and translations . New words have been coined to understand hidden science of mind part of reality. Mind reality has been recognized as different faces by “I” about 5000 years back to Arjuna in Mahabharata.as shown in Fig 1. It is just like to understand any language through Alphabets. These are (different faces) Alphabets of mind reality. One Mind reality has one face identity and the second mind reality has second face identity and so on. The facial expression represents phenomenon of intelligence and different faces represent different types of properties carrying property. The open eyes means property is activated while close eye means property is inactivated. In spite of carrying properties conscious ness they also know how to conduct not only origin of universe but also how to create two different universe i.e. next creation could be different from this creation . In all, it is automatic system of the universe . The mind realities which are of good properties have devtas face identity (first five faces on both side) and those mind realities which are of bad properties have demons face identity (last four faces on both side) . These are named as code PCPs or messenger atomic genes . The central face is CCP or Thought script where all thoughts of the universe are banked . It is bank of data of all information s of the universe It is face identity of Anti mind particles as data of all information’s of the universe are stored as anti mind particles . It is the Time mind ness (biological clock) that keeps on expressing different thoughts from this thought script (CCP) . There are four more faces (black bodies) shown on extreme left and right floating in fire are CPs (translating Atomic genes) . That translates the messages and realizes it and reacts accordingly.[2]

1.3. Messages From Biological world to understand B.B.B world as shown in Fig 2 [2]

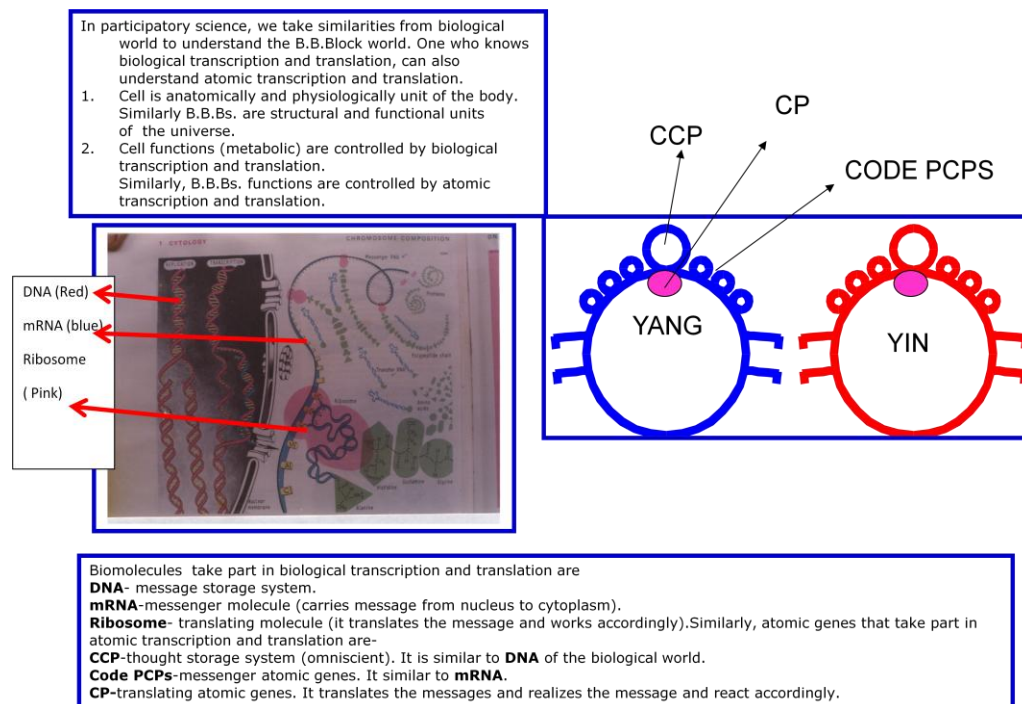
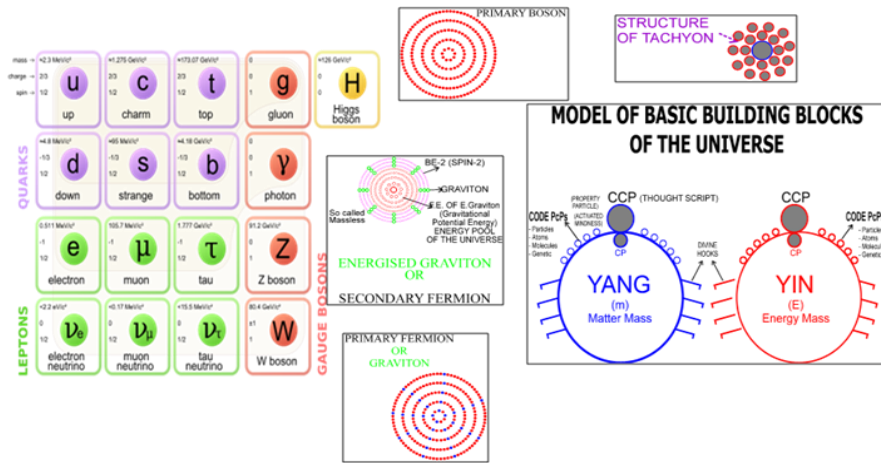

Fig. 2 Parallel teaching by participatory science

The standard model not only modified rather it has been completed [3] with introduction of energized gravitons , primary fermions, primary bosons , Basic Building Blocks , Mind and Tachyons as shown in Fig 3



Standard model completed with Fundamental particles and Mind And Tachyons

Fig. 3 standard Model chart [3]

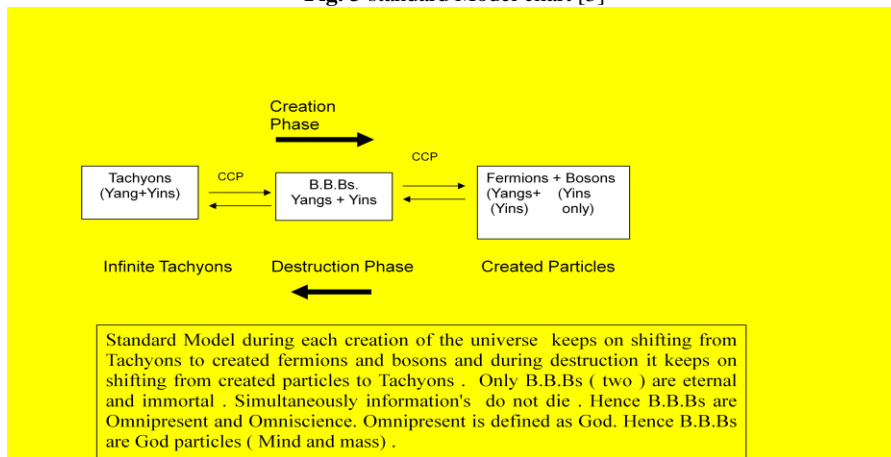

Fig .3.1 one creation and destruction cycle [4]

Participatory science has coined [5] some new words and there are some words which already exist in physics. Both these words are defined here and the definitions are according to participatory science. It has no relation with the definitions given in modern physics.

- 1.Mass - The part which gives shape to the smallest mass unit i.e. basics building blocks (B. B. Bs.) is called mass.
- 2.Matter :-Mixture of fermions and bosons or only bosons which are made up of mass (B.B.Bs) and that is why we realize their shape is called matter.
- 3.Inertial mass :-Mass (smallest mass units i.e. B. B. Bs) having inertial properties (classical inertia) either absolute rest or uniform motion in straight line is called inertial mass. Or Number of B. B. Bs. Per unit space present in bigger units is called inertial mass. Or Total matter contained by the bigger units or total number of fermions and bosons contained by the bigger units is called inertial mass. Therefore it never changes from place to place.
4. Gravitational mass :- The mass (interacting surfaces) which takes part in gravity (divine energized gravitons theory) interaction (which is due to mind) is called gravitational mass. When gravity interaction increases (number of divine energized gravitons increases) the interacting mass (interacting surface) also increases or when interacting mass (interacting surfaces) increases, gravity interaction (number of divine energized gravitons) also increases. Therefore gravitational mass (interacting mass or surfaces) changes from place to place. It is the fed mind that decides gravity interaction. We shall discuss it in gravity chapter and in atomic genetics.
5. Pure m (matter) mass :-matter mass (smallest mass unit or B.B.B) which have got inertial property of absolute rest.
6. Energy mass:-Energy mass (smallest energy mass unit B.B.B) which have got inertial property of uniform motion in straight line and which also gives shape to the bigger energy mass (Higgs Bosons etc) units.

7.m (impure matter) of $E=mc^2$:-Matter particles (fermions) which have got spin property are called impure matter particles.

1.4 Prayer message formation in brain.

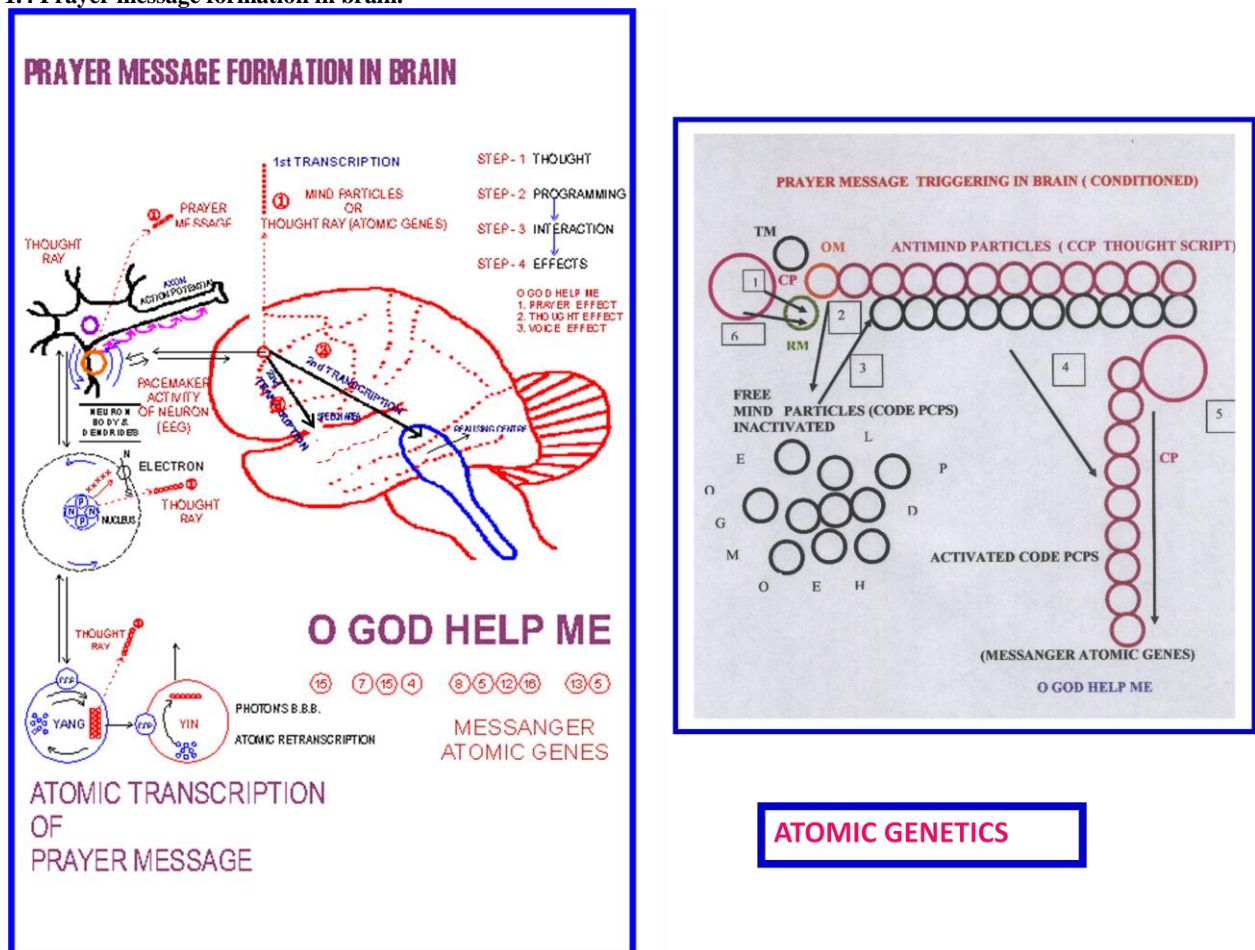

Fig 4 Divine Mechanics - Prayer message formation in brain

In atomic transcription and translation of prayer [5], following steps take place on Yang B.B.B – B-Bit as shown in Figure 4.

- 1.CP removes RM (repressor mindness-green) from OM (operating mindness -orange) thus induction of atomic transcription triggers.
- 2.OM triggers activation of free mind particles (black -inactivated code PCPs) of that thought script (magenta) of “o god help me”.
- 3.Free mind particles (black -inactivated code PCPs) get attached to anti mind particles script (magenta one) to form messenger thought script of “o god help me”.
- 4.Messenger atomic genes (black) get activated by anti mind particles thought script and further they get detached from anti mind particles thought script to form activated messenger atomic genes (activated code PCPs) (magenta) of “ o god help me”
- 5.CP carries phenomenon of splicing by translating the messenger activated atomic genes (activated code PcPs) and finally there is activated message of “ o god help me” is formed .
- 6.CP represses atomic transcription by adding RM (green) to OM (orange) . Thus atomic transcription gets halt.

Having formed the message it comes out in three forms .

In atomic genetic engineering (prayer) we use our basic power i.e. power of B.B.Bs. Our B.B.B. (higher center) talks with highest center of the universe by sending the message by first transcription. Till today nobody knows how does the brain generate thoughts. I am going to tell you that mystery too. In the frontal lobe the neurons are responsible for thought generation. In the neuron there is electrical activity called pacemaker activity which is occurring between dendrites and the body of the neuron. The membrane of the cell is made up of atoms and atom is made up of B.B.Bs. At the level of B.B.B. say thought of 'O GOD HELP ME' is expressed. As a result programmed messages of O GOD HELP ME (code PCPs) are formed. Out of three programmed messages, one is carried by atomic genes to highest center of the universe. It is called **THOUGHT RAY (Quantum entanglement)** which is made up of pure atomic genes and then the message goes through phenomenon called first transcription. They come out from brain directly. The other two messages are carried by photons

from nucleus of atom to electrons. Here they are modulated on electrical activity of the cell called pacemaker activity. Further they are modulated on actions potentials going towards **REALIZING CENTER** situated in brain stem (RAS) and from RAS to speech area situated in the frontal area. Target B.B.Bs. of the realizing center finally realizes thought effect of O GOD HELP ME. While from speech area message goes to motor cortex again via RAS and from there to vocal cords and finally it comes out as a speech effect of O GOD HELP ME. In layman's terminology formation of the thought ray means PRAYER as shown in Fig 4

Where Does Prayer Message go ?

Prayer message goes as shown in Figure 5 to highest center of the universe via first transcription where it is realized and it is accepted, the highest center sends two messages to B.B.Bs working as higher center in cancer cell. These messages are message of inhibition of abnormal thought expression and message of activation of normal thought expression. Having received the messages, higher center stops expressing the abnormal thoughts and it starts expressing the normal thoughts. As a result, there are no more abnormal programmed messages and in place of that normal programmed messages are there. Now the messages have shifted from abnormal (5 and 6) to normal (2 and 3). This shifting of thought expression is called **ATOMIC GENETIC ENGINEERING** as shown in **Figure 4.1**

The changed messages reach to target B.B.Bs. through same route. Having received the changed messages, target B.B.Bs. stop expressing the previous programming and they start expressing the normal programming. As a result the cancer cells transmutate into normal cells. Or **diseased cell gets cured [6]** as shown in **Fig 4.1**

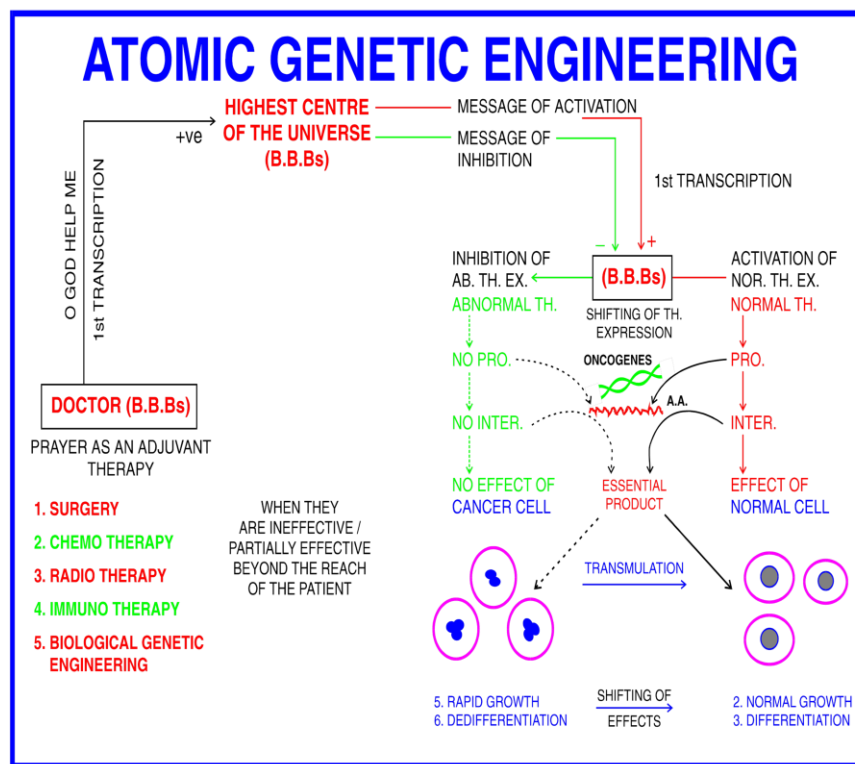

FINAL STAMP OF SUCCESS TO THE THEORY

A Randomized, Controlled Trial of the Effects of Remote, Intercessory Prayer on Outcomes in Patients Admitted to the Coronary Care Unit

Context Intercessory prayer (praying for others) has been a common response to sickness for millennia, but it has received little scientific attention. **The positive findings of a previous controlled trial of intercessory prayer have yet to be replicated.**

Objective To determine whether remote, intercessory prayer for hospitalized, cardiac patients will reduce overall adverse events and length of stay.

Design Randomized, controlled, double-blind, prospective, parallel-group trial.

Setting Private, university-associated hospital.

Patients Nine hundred ninety consecutive patients who were newly admitted to the coronary care unit (CCU).

Intervention At the time of admission, patients were randomized to receive remote, intercessory prayer (prayer group) or not (usual care group). The first names of patients in the prayer group were given to a team of outside intercessors who prayed for them daily for 4 weeks. Patients were unaware that they were being prayed for, and the intercessors did not know and never met the patients.

Main Outcome Measures The medical course from CCU admission to hospital discharge was summarized in a CCU course score derived from blinded, retrospective chart review.

Results Compared with the usual care group (n=524), the prayer group (n=466) had lower meanSEM weighted (6.350.26 vs 7.130.27; P=.04) and unweighted (2.70.1 vs 3.00.1; P=.04) CCU course scores. Lengths of CCU and hospital stays were not different.

Conclusions Remote, intercessory prayer was associated with lower CCU course scores. This result suggests that prayer may be an effective adjunct to standard medical care .

Arch Intern Med. JAMA--Vol-159, N019 , Oct-25, 1999 :2273-2278

Fig . 4.1 A.G.E and Final stamp of success to New Theory[6]

1.5 Message system of the Universe

Before the origin of the universe [2] nature had only one type of message systems which is called **FIRST TRANSCRIPTION**. Messages (Code PcPs) used to go from one B.B.B. to another B.B.B. by atomic transcription. Messages were carried by atomic genes (Code PcPs) with very very high velocity. It is the fundamental message system.

After the origin of the universe, nature created atoms. It also created one more message system called **SECOND TRANSCRIPTION**. Here the message (code PcPs) are carried by photons from one atom to another atom with velocity of light. Thus atoms, molecules, cells, and even individuals talk with one another

After the formation of the cell, nature created one more system called **THIRD TRANSCRIPTION**. Here there is a message storage system formed by DNA. There are messenger molecules called mRNA that carry message from DNA script to cytoplasm where the message (code PcPs) is read or translated by ribosome and they work accordingly. Thus the messages reach to enzymes and hormones and finally messages reach to target units. Having received the messages, target units work accordingly. Finally life effects (metabolic) are observed.

These three types of message systems are working in the nature. These message system are being used by the nature according to nature's need. as shown in Fig 5

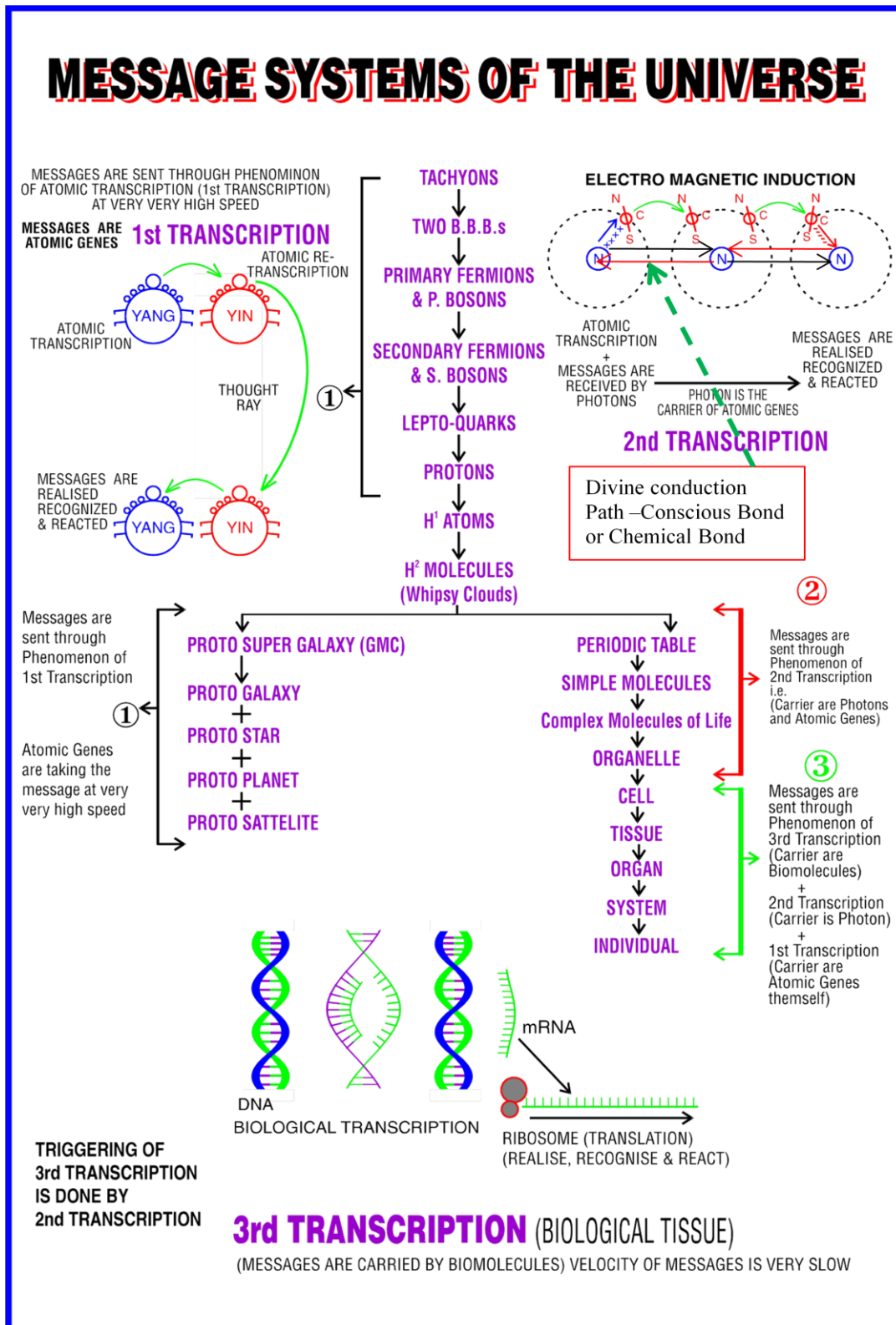

Fig. 5 Messages system of the universe

1.6 How does nature work & triggering of normal & abnormal effects

To understand creation physics as shown in Fig 6 and Fig 7. . There are two types of thought stimulation [2] . One is CONDITIONED THOUGHT STIMULATION and other one is UNCONDITIONED THOUGHT STIMULATION.

STIMULATION OF THOUGHT EXPRESSION --- There are two types of thought expressions one is **CONDITIONED STIMULATION** of thought expression, and other one is **self stimulation of thoughts** i.e. **UNCONDITIONED STIMULATION** of thought expression .

At the time of the origin of the universe, all effects got created. The cause of all effects of the universe is **THOUGHT** expression. These thought expressions were triggered by **UNCONDITIONED OR SELF STIMULATED WAY** . It is the first step and it is followed by **PROGRAMMING** or formation of programmed messages by code **PCPs**. This programmed message moves from higher centers to target **B.B.Bs**. it is called **INTERACTION**. Having received the messages, the mind and mass of the target **B.B.Bs**. work in a synchronized way so as to produced the effects as thought by a the higher center. If the thought expression by higher center is normal, the shapes, properties and laws produced by target **B.B.Bs**. would be normal and if the thought expressions are abnormal, the shapes, properties and laws would be abnormal. This is the basic concept of **transmutation phenomenon**. Finally what we observe is called **EFFECT**. Appearance of new shapes. properties and laws is called **TRANSMUTATION**. The first three steps are collectively called **CCP**. During transmutation process if **CCP** is written, it does mean that unless the thought, programming and interaction take place, nature cannot transmutate. Transmutation phenomenon is seen in particles, atoms, molecules and even in cells. The basic steps of any transmutation remain the same except that the thought expressions differ.

The subatomic particle are made up of more fundamental particles called Basic Building Blocks (B.B.Bs) which are made up of mind and mass. These B.B.Bs are divine in nature with the result they talk with each other by phenomenon called atomic transcription and translation (thought expressions). The triggering of broken symmetry is caused by atomic transcriptions. Unless the atomic transcriptions occur, subatomic particles could never exhibit phenomenon of broken symmetry . So the broken symmetry is never spontaneous. It is being mis understood that sub atomic particles do have spontaneous activities as far as broken symmetry is concerned. Hence the Nobel prize physics 2008 awarded to this work is too early to give prize.

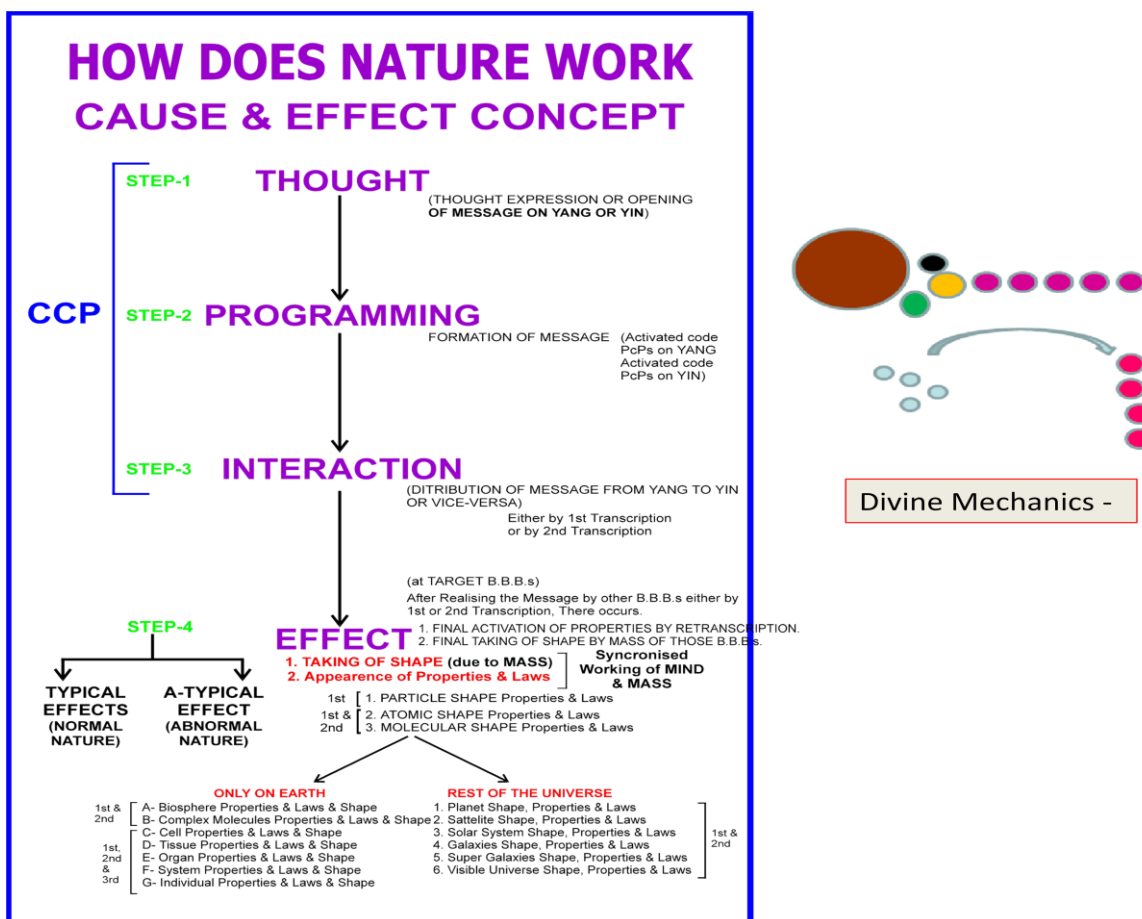

Fig. 6 Divine Mechanics – How Does Nature work ?

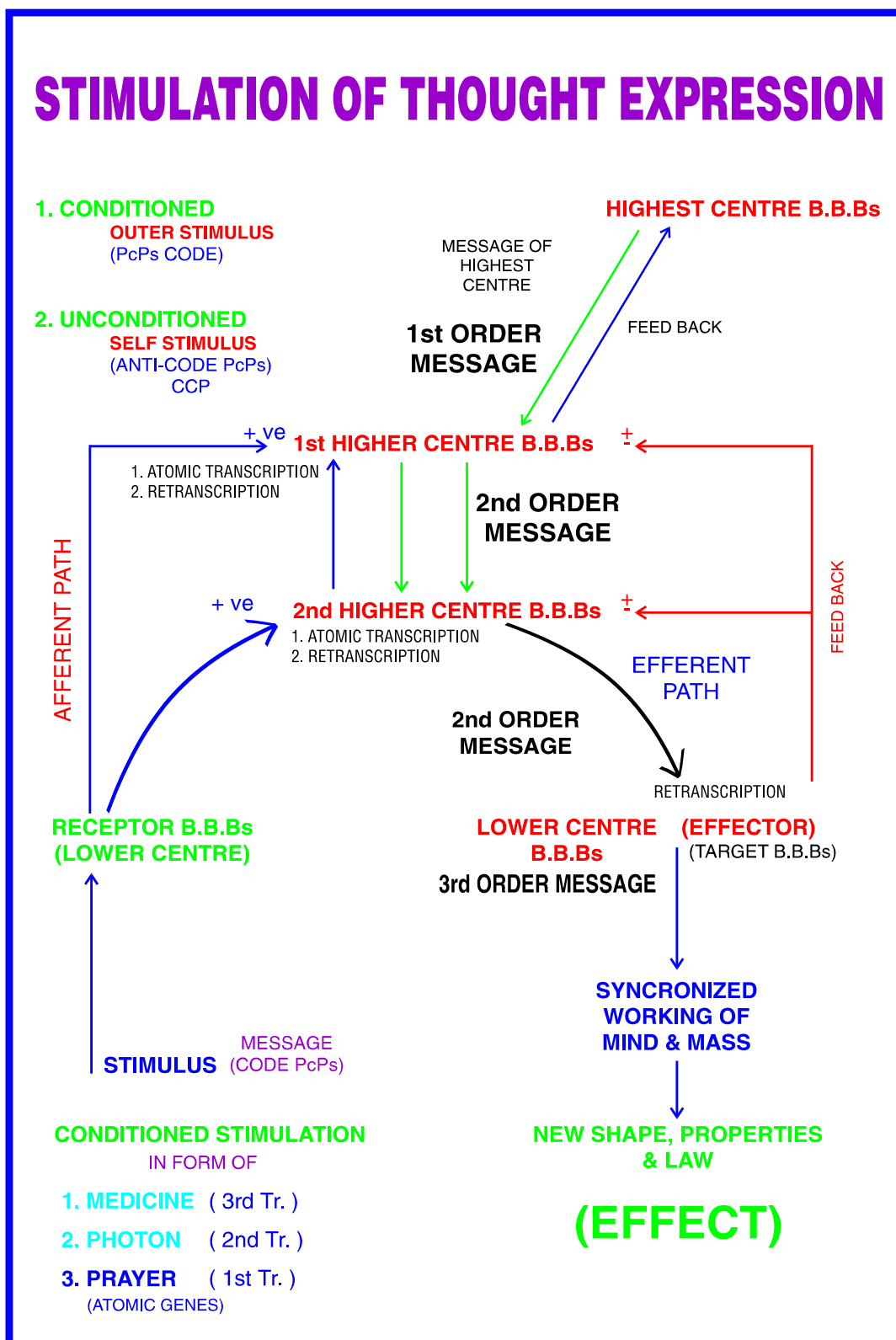

Fig. 7 Conditioned and Unconditioned thought expressions

1.7 Message network of the Universe (Feed Back Mechanism and different centers of the Universe)

With the origin of universe, nature first created primary units i.e. primary fermions (gravitation) and primary boson, these primary units are equipped with one higher center (one B.B.B.) and rest of the B.B.Bs. are working as lower centers or target B.B.Bs.[2] After primary units ,nature created secondary units i.e. secondary fermions and secondary bosons. similarly

nature created tertiary units (lepto-quarks) and then quaternary units (protons& neutrons). Each unit is equipped with higher centers, lower centers and target B.B.Bs. After quaternary units nature created atomic units, molecular units, complex molecules of life units, organelle units, cell units, tissue units, organ units, system units and individual units. Each unit is equipped with higher centers, lower centers, and target B.B.Bs. Similarly nature created satellite units, planet units, solar system units, galaxy units, super galaxy units, dark matter layer unit. These units are also equipped with higher centers, lower centers and target B.B.Bs. Thus our universe is divided into different units and each unit is equipped with higher and lower centers. All higher centers are under control of highest center of the universe by efferent paths. This efferent path is made up of first transcription. Higher centers can send messages to highest center of the universe by afferent path or feed back path. Thus highest center of the universe is well informed about all effects of the universe. Messages can come from lower centers to higher centers and from higher centers to highest center of the universe via afferent path. The highest center of the universe can send messages to higher centers and from higher center to lower centers. There is an inter unit message network also which is made up of first, second and third transcription depending upon the nature's need. Thus the entire universe is under control of highest center of the universe. Highest center can change any programming programmed by it during pre creation era as shown in Fig 8

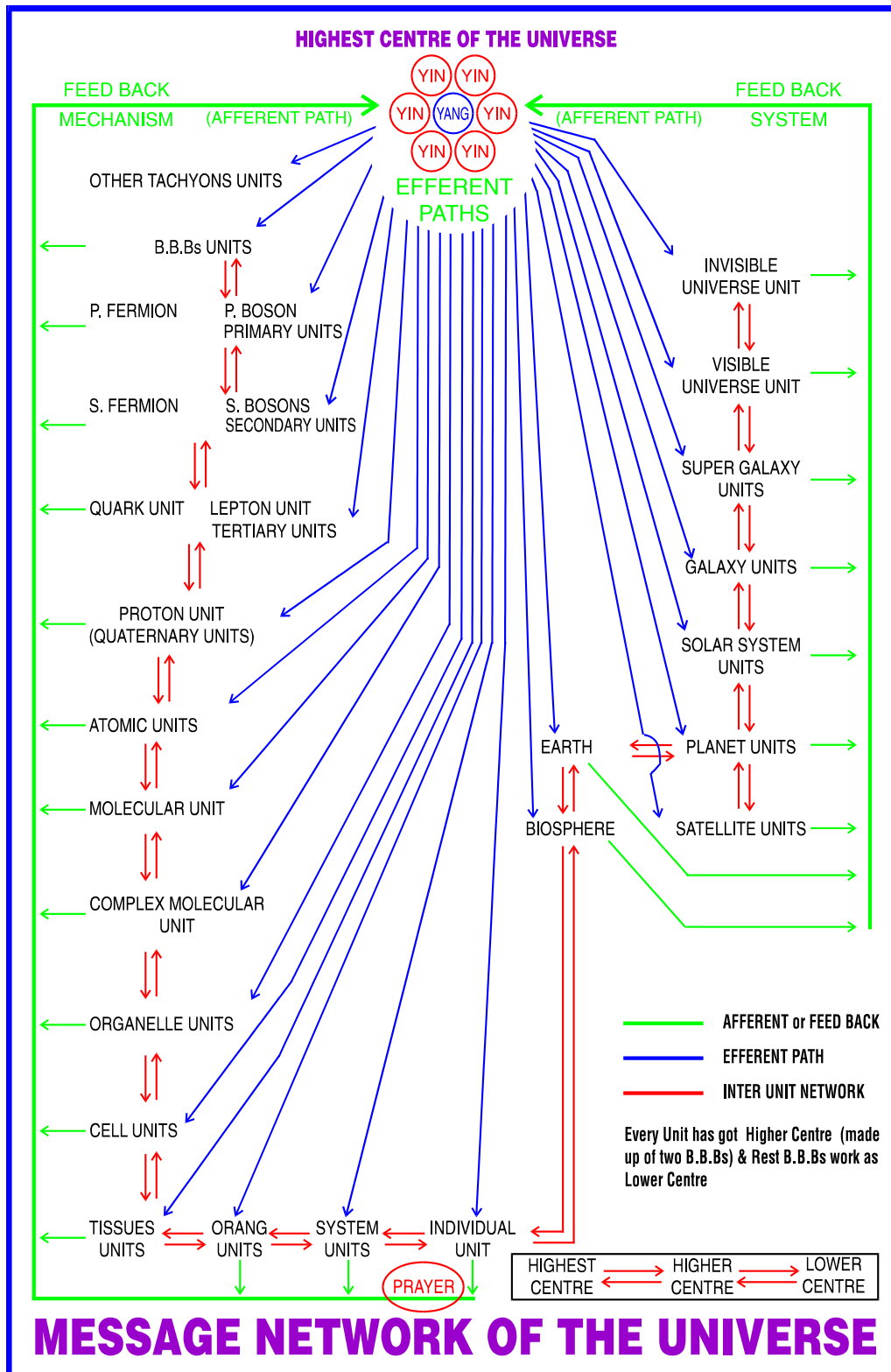

Fig. 8 Messages Net work of the Universe

1.8 Origin of the universe [7]

Hoyle – Narlikar Universe



ORIGIN OF THE UNIVERSE CONTINUOUS CREATION THEORY----

HOYLE AND NARLIKAR THINK THAT NEW MATTER IS BEING CREATED DUE TO 'IMPLOSION' TO BALANCE THE EXPANSION OF THE UNIVERSE, WHICH ASTRONOMERS HAVE OBSERVED. INSIDE 'QUASI STARS' GRAVITATIONAL COLLAPSES MAY FORM SOME MATTER IN THE UNIVERSE. THE HUGE LUMINOSITY AND THE RADIOEMISSION FROM THESE QUASI -STARS APPEAR TO BE 'GRAVITY POWERED' UNLIKE ORDINARY STARS WHICH DERIVE THEIR ENERGY FROM NUCLEAR REACTIONS

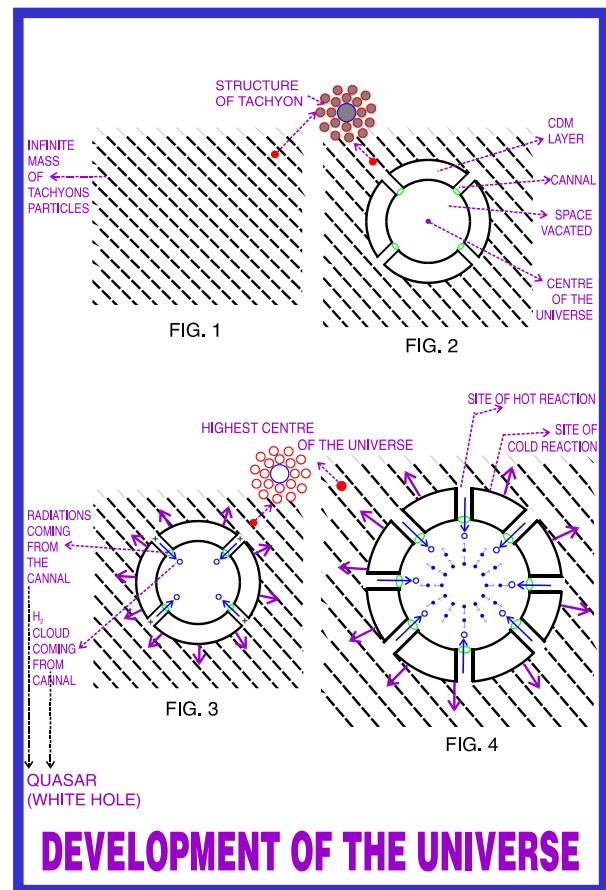

Fig. 9 Development of the Universe

Before the origin of the universe, these Basic Building Blocks (B.B.Bs) as shown in Fig-3 were in the form of tachyons as shown in Fig-9 [7]. It means that at that time the tachyons were everywhere in the universe. Let us look at the structure of tachyons; it is made up of one matter B.B.B. (YANG) and many energy (YINs) B.B.Bs. Initially out of the infinite tachyons, one became the **highest center** of the universe. Messages used to go from highest center to rest of the universe and messages could come from rest of the universe to highest center of the universe by atomic transcription. Thus highest center had fed its thought to rest of the B.B.Bs. that would take part in creation - that they would express only those thoughts to give desired effect as wished by the highest center of the universe. So all B.B.Bs were informed about their role before creation of the universe. In pre-creation era programming of the future universe was done by highest center of the universe. Our universe is oscillating and it is a divine universe. It means that it has a creation phase and a destruction phase. During creation phase tachyons break into their B.B.Bs. and from these B.B.Bs, formation of fermions and bosons take place as shown in Fig 3.1. After the creation phase, destruction would start and in this phase all created particles would again break into their B.B.Bs and finally tachyons would form. At the time of origin of the universe, all the effects got created. These effects are taking of different shapes and appearance of properties and laws. All these effects are studied in various branches of science.

With the origin of the universe, nature first created a sphere of **COLD DARK MATTER (C.D.M)** and canals in it. With the result space got created. At the other end of the canals, hot reaction started (**the relics are back ground radiations 2.7 degree K of our hydrogen clouds**). As a result hydrogen clouds and lot of radiations were created. The empty canals were filled by these hydrogen clouds and radiations and thus **QUASARS** appeared in the universe. Simultaneously C.D.M. layer started expanding and clouds and radiations kept on coming in this closed universe as shown in Fig 9 . With the passage of time more and more C.D.M. layer formed, more and more quasars formed. The hydrogen cloud came in this closed universe. They started running towards C.D.M. layer as they were attracted by the gravity of C.D.M. layer. Those clouds, which were nearer, moved faster than those, which were away from CDM Layer. The **HUBBLE LAW**, can thus be explained. With some more passage of time, clouds were joined to form **GMC** (giant molecular clouds). Later by self-gravitation different proto stars, proto planets, proto satellites were formed. Finally stars became bright and thus bright galaxies appeared in this universe. Our universe is still in expansion phase and creation is still going inside quasars. It is to be remembered that

highest center of the universe does not come in the visible universe. It keeps on receiving the messages by atomic transcription and it has power to change any programming programmed by it during pre-creation era. It is the atomic genes which constitutes mind part of reality. Mind incorporation in physics is awaited as theory of every thing is not yet investigated . I have investigated theory of every thing (ToE) and I found that while studying unified theory at the time of origin of the universe by Hoyle Narlikar universe , it was mind reality that triggered symmetry breaking phase . It is mind reality that triggers oscillation phenomenon of the universe. It is the mind reality which is behind perfect cosmological principle . There is nothing like artificial intelligence in the universe . These mind particles constitute intelligence of the universe that controls the deterministic order of the universe. It is the mind reality behind all effects of the universe. But this is not our mind rather it is mind of Almighty B.B.B (Yang B.B.B or matter B.B.B. or Male B.B.B working as Highest center of the universe) . His mind could be manipulated by prayer only . as shown in figure 9.1 and 9.2

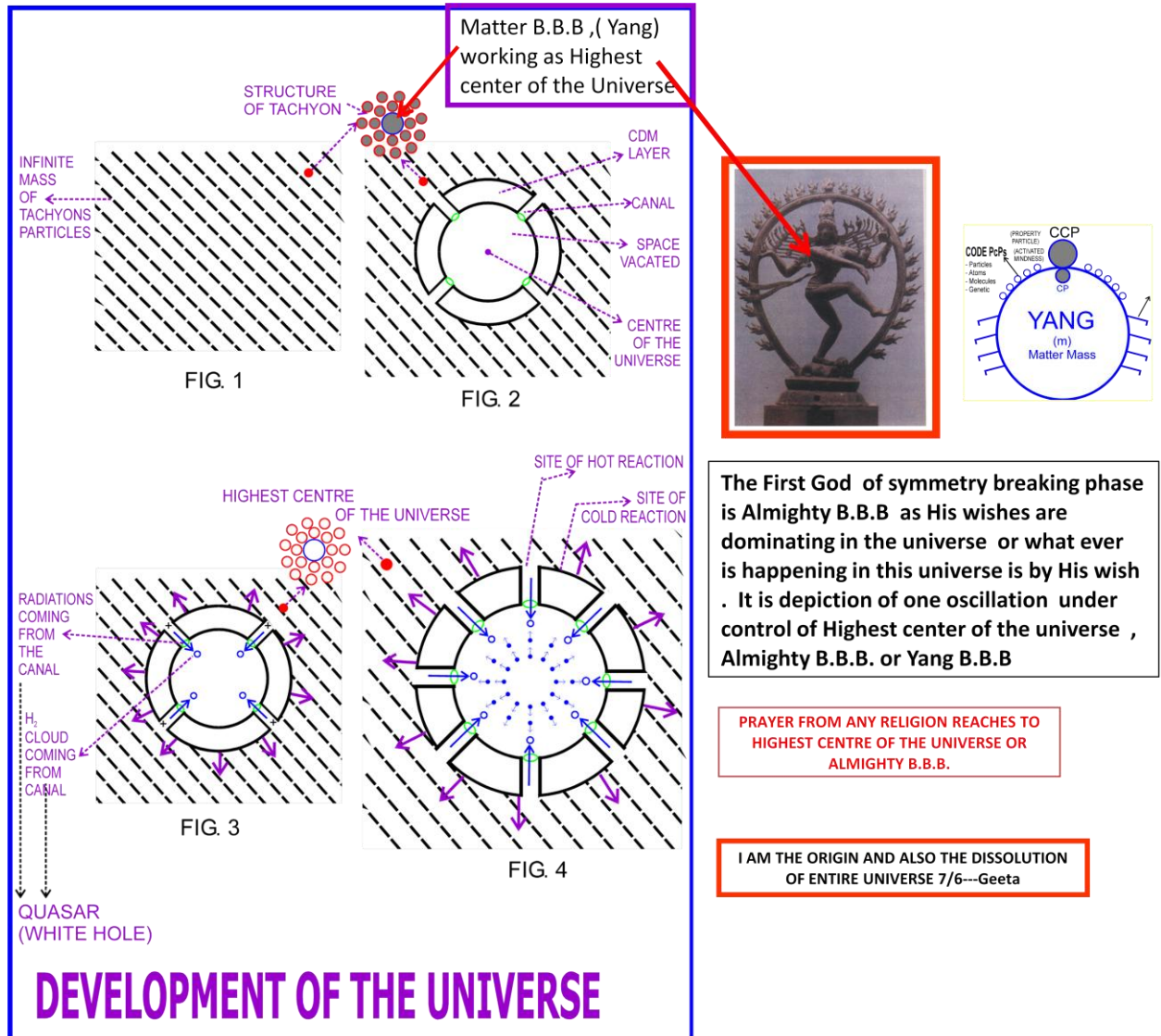

Figure 9.1 Hoyle Narlikar Universe

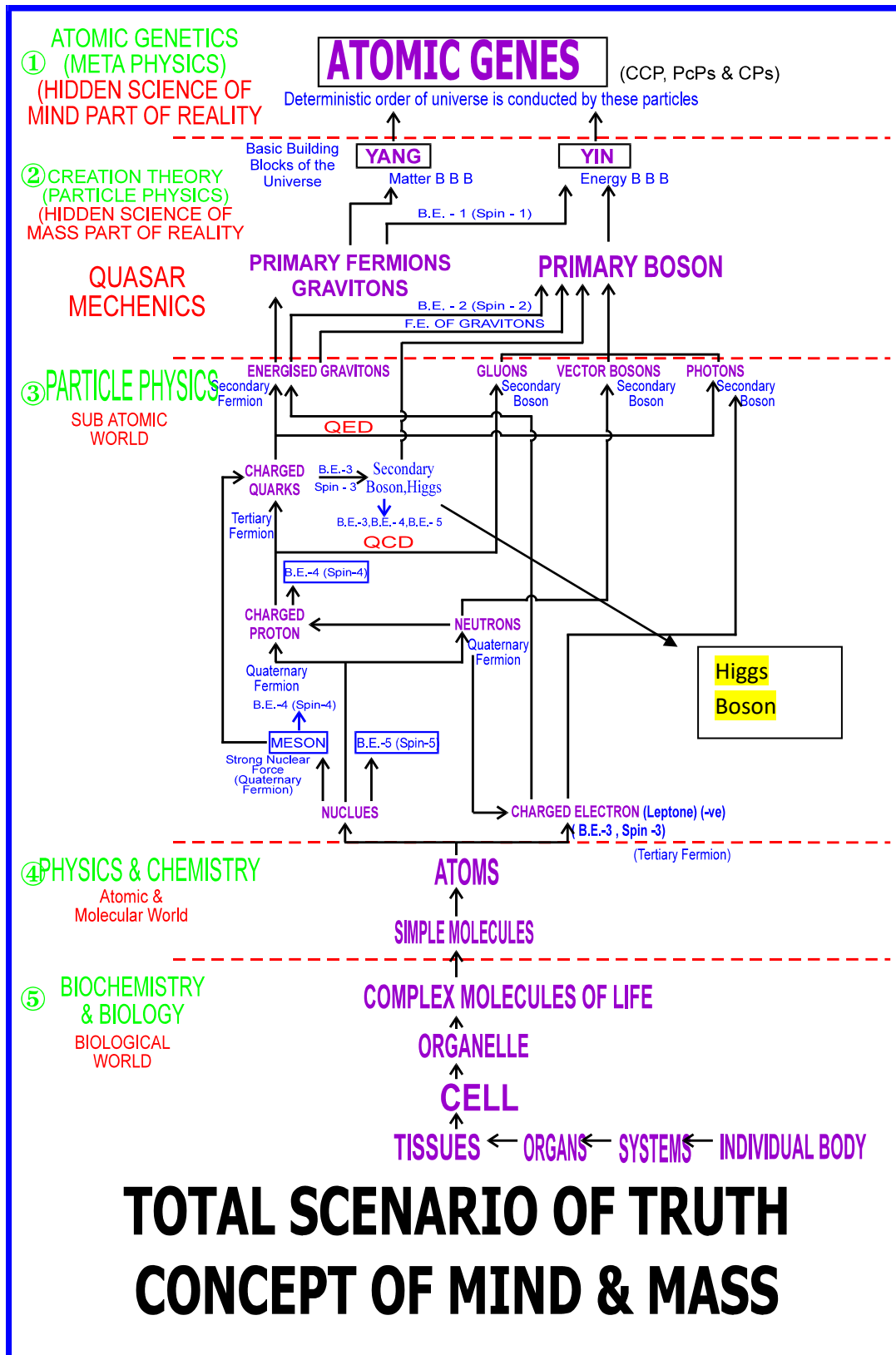

Fig 9.2 Total scenario of Truth Mind and Mass

1.9 DM and DE i.e. energized gravitons and energy pool of the universe as shown in Fig 10 and Fig 11 [8]

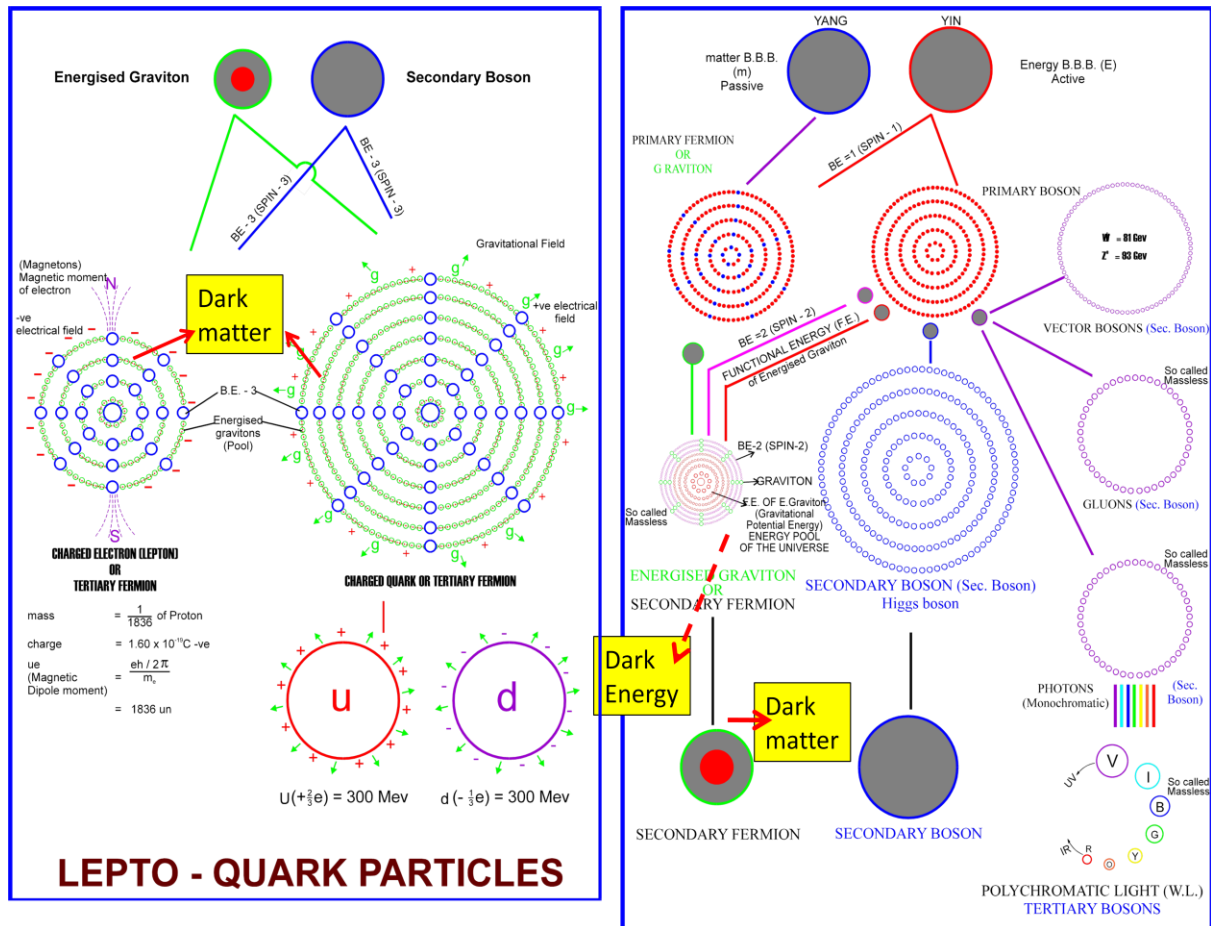

Fig. 10 Structural configuration of Leptons and Quarks as regard DM and structural configuration of DM and DE at micro level

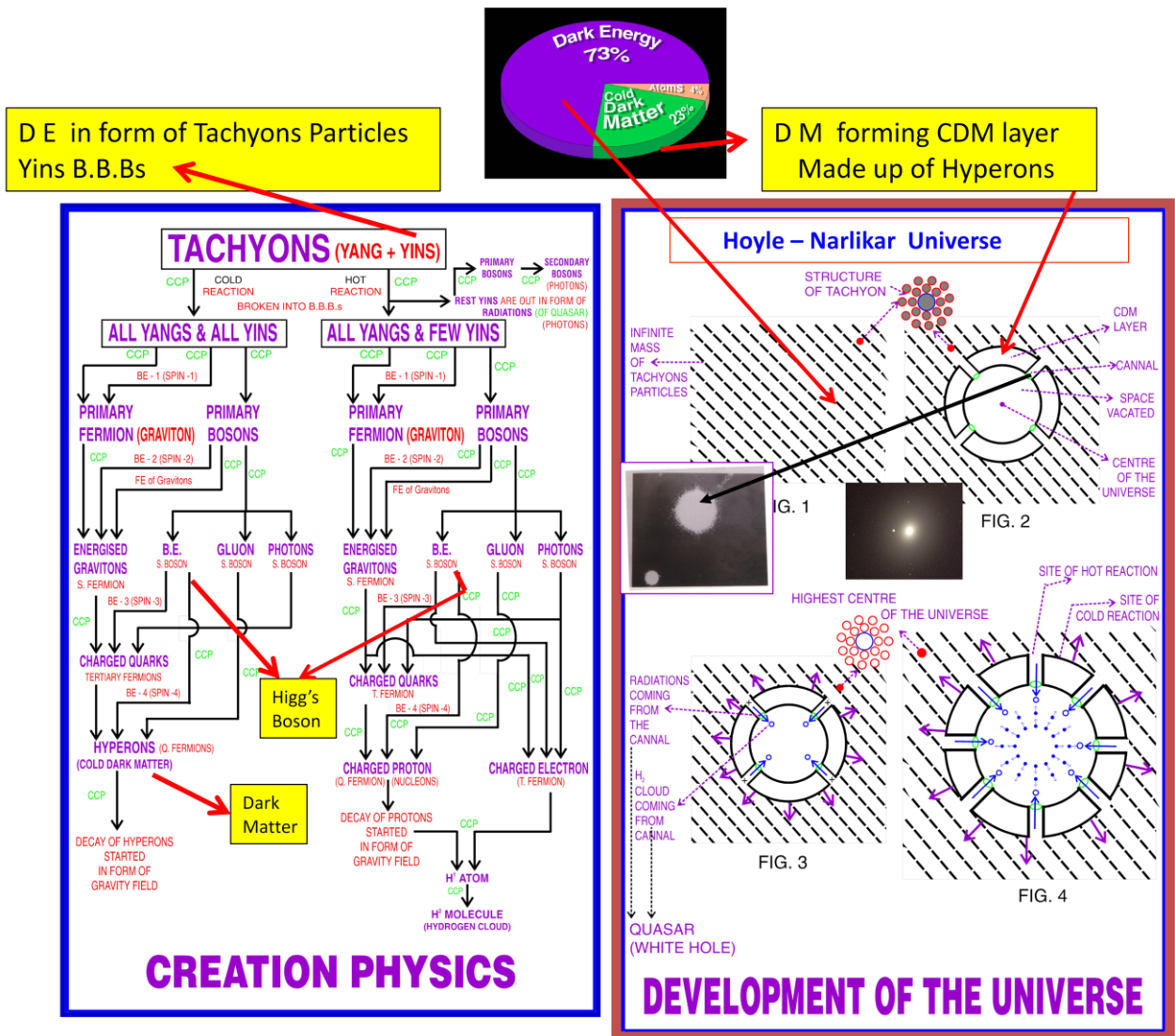

Fig 11 structural configuration of DM and DE at macro level [9]

1.10 Divine Mechanics and Brain Computation

Learning and Memory and informations (Code PcPs) Net work in Brain [10]

(Structural and Functional smallest Bit (mass) is B-Bit of the universe and the Divine Mechanical Unit is CCP , Code PcPs and CP.)

DIVINE MECHANICS The Theory of Computers and Brain is SAME as shown in Fig 13

Physics dictates the lowest limits of the size of chips [11]. But divine mechanics does not . Hence the bit is a typical unit of information. ((Classical and Quantum Bit) is wrong and to describe informations by adding qubit is also illusion as in complicate system ,it is the different thoughts expressions that describe informations . Informations are separate (Code PcPs) and bits (Electron of transistor) qubits (electron of diamond crystal) are separate. At DNA level the bit is nucleotide (A,T,C,G) and at Atomic level the bit is photon and electron , at particle level (secondary fermions and secondary bosons) the bit is primary fermions and primary bosons and informations are still code PcPs and at B.B.B level the bit is B.B.B (Yang mass and Yin mass - B- bit) it self and the information is carried by Code PcPs but at all level of all bit units the information storage system is CCP (Physiological arrow of Time) it never dies even after destruction of the universe. Hence information s are eternal . In computers, Bit is a structural configuration that describes information s of the system and information s are in form of Code PcPs. The working of the bit is triggered and controlled by thoughts of higher centers that form that bit. If the bit is classical (transistors of chips) the effect is different . But if the bit is qubit with entanglement the working is triggered and controlled by thoughts of higher center that form that crystal . In both the effect of describing informations would be different.

One is classical (thought expressions are fixed and limited)and other one is quantum (thought expressions are changing and more wide to describe the more wide complicated system to have fast results .) . In life sciences in Brain the bit is again Photon and the information s are Code PcPs and they are triggered and controlled by CCP of higher centers that is triggered by DIVINE MECHANICS .

In life sciences the CCP (cryptography) of B-bit expresses informations (Code PcPs) which were not fed like speaking Lie and unlike Bit of classical computer and qubit of QC it shows phenomenon of forgetfulness and IQ phenomenon (mental age /real age) . It is Higher functions of B.B.B or B Bit and it is life . Hence there is difference in some aspect of DIVINE MECHANICS \of Computers computation and Brain computation

1.11 Phenomenon of Oscillation in micro particles – Photon’s Oscillation

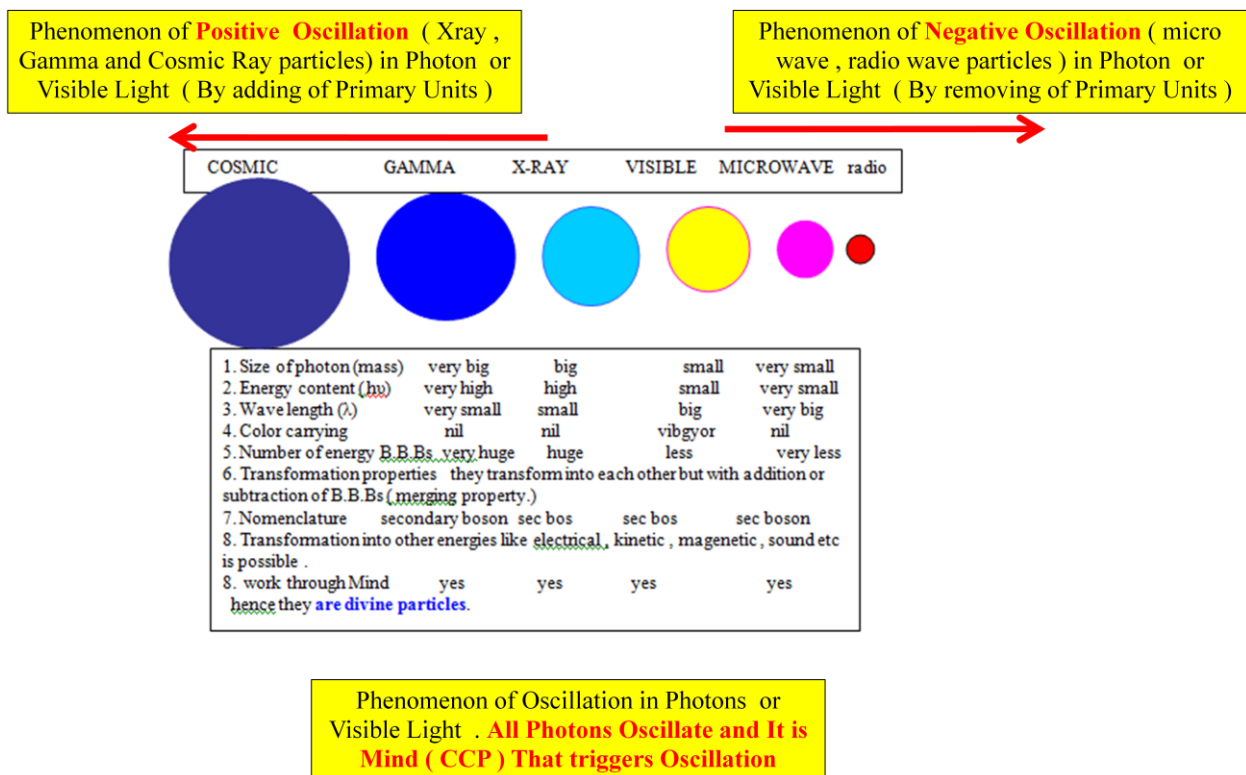

Fig 14 – Phenomenon of Oscillation in Photon

Structure

2.1 Modified theory of atomic structure as Niels Bohr's theory has limitations in explaining different series of hydrogen spectra.

New assumptions of structure of hydrogen atom. – Divine Modified Niels Bohr 's Theory (**Divine MONB**) as shown in Fig 15

1. Hydrogen atom is like a miniature solar system with the negatively charged electron moving in circular orbit around positively charged nucleus having positively charged particle proton. In this circular orbit or stationary orbits , electron is being held by single string of energized gravitons . This energy level is called ground state.
2. When Hydrogen atom is excited, the electron moves from ground state to excited state energy levels making a bigger circular orbit and having reached in this new energy levels , it also emits radiations . Hence absorption and emission of energy quanta occur simultaneously. Shifting is understood in inter orbital shift phenomenon.
3. When excitation is over, the electron once again come back to ground state energy level . All above mentioned events are triggered by different thoughts or atomic transcriptions from the nucleus or proton in case of hydrogen atom.
4. These atomic transcriptions are being triggered by conditioned stimulation of CCP by the message system made up of photons (second transcription or –ve charged photons or afferent path) coming from electron to proton and further they are transmitted by photons (second transcription made up of +ve charged photons, or efferent path) to electron. Having received the messages , electron works accordingly. Unless the thought is expressed, nature cannot work . as shown in Fig 15
5. When electron is in ground state, its interaction with energized graviton and electromagnetic photon is more hence IP -13.59ev (n=1) is required to remove electron from this energy level. During excited stage the interaction is different hence I.P. to remove electron from this state is -3.4ev (n=2), -1.511ev (n=3),- 0.850ev (n=4) , -0.544ev (n=5) respectively. It the changing thought of interaction with energized graviton and electromagnetic photons that gives changing effect .
6. Electronic configuration of higher atoms could be known by studying I.P. curve . Working of hydrogen atom as shown in Fig 15 .

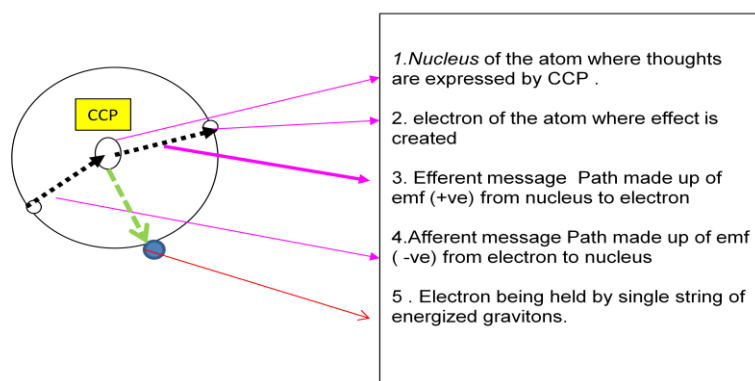

Fig 15 working of hydrogen atom – Divine MONB Theory

2.2 Conditioned stimulation of CCP and phenomenon of life .

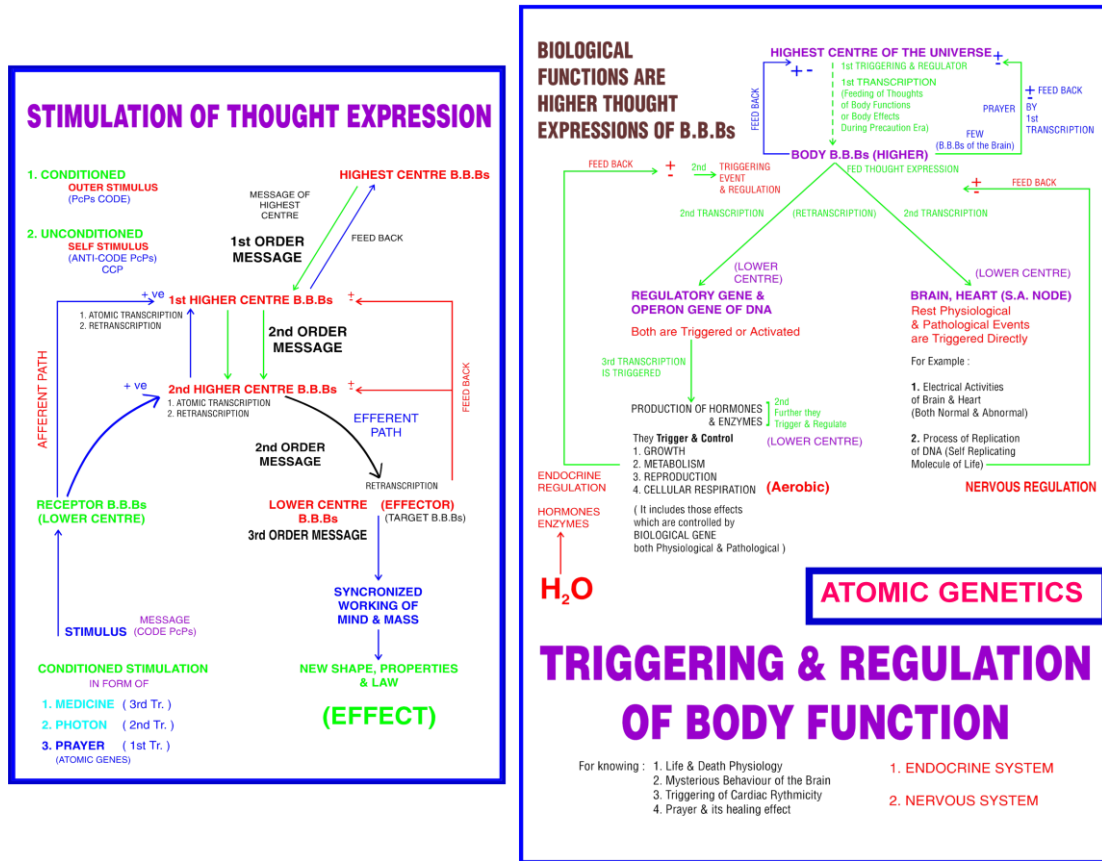

Fig 16 Stimulation of thought expression by conditioned

Few body functions are triggered by unconditioned thought expressions like mysterious behavior of brain i.e. creative thoughts , few dreams and triggering of cardiac cycle i.e first systole in utro . Few other functions are triggered by conditioned stimulation of thoughts like life and death physiology i.e. if you add water , you would see life effect and if you remove water , you would see death effect and prayer and its healing effect.

2.3 unconditioned and conditioned stimulation of CCP in life phenomenon

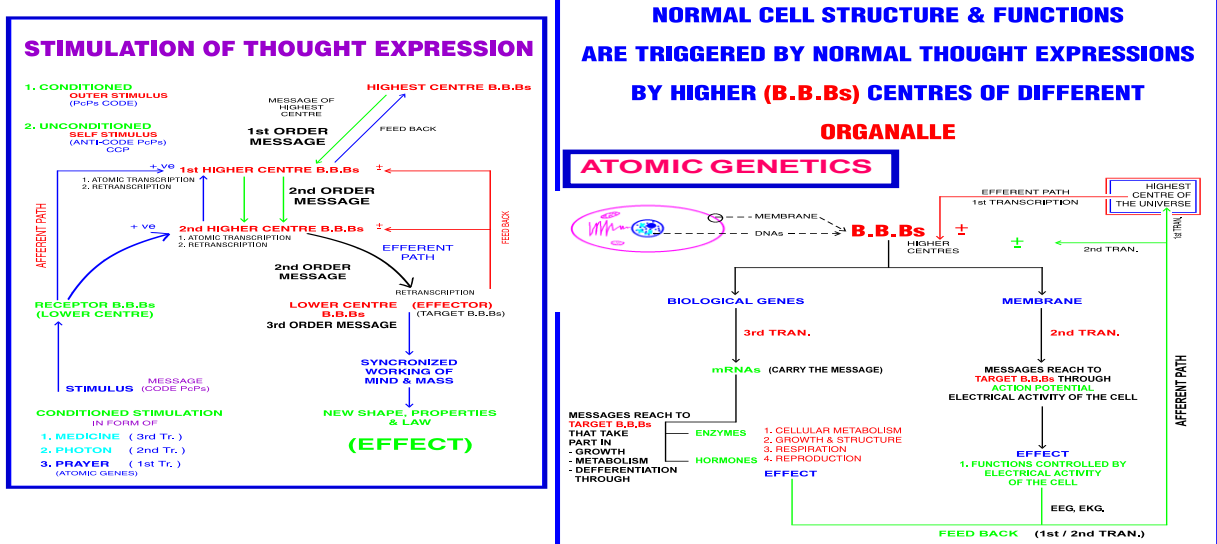

Fig 17 Stimulation of thought expression by unconditioned or conditioned in our body

Triggering and regulation of cell functions or cell physiology as shown in Fig 17

Normal cell structure and function are triggered by atomic transcriptions or thought expressions by higher centers (B.B.Bs.) present inside the cell. These higher centers are found in **DNAs** and in the membrane. Higher centers in **DNA** express thoughts. The programmed messages (code PCP) are carried by photons from nucleus of the atom to electrons. Thus messages come on the surface of **DNA** molecule. These messages shift to mRNA during third transcription. **mRNAs** carry the messages (code PCPs) from nucleus to cytoplasm where messages are translated by ribosome. Simultaneously, messages shift to peptide chains (enzymes & hormones) These enzymes and hormones carry the messages to target units (B.B.Bs.). Having received the messages, target units work accordingly and life effects like metabolism, cellular respiration, growth and structure formation, and other metabolic effects are observed. There is feedback of the effects to the higher centers. Thus triggering and regulation of metabolic functions are carried out. Similarly, the higher centers of membranes express thoughts. These thoughts are carried by photons from nucleus to the electron of the atom. Thus messages (code PCPs) come on the surface of the membrane. Here they are modulated on pace maker electrical activity and further on action potential and thus action potential (second transcription) carries the messages from one part of the cell to the other part of the cell. This is called electrical effects (EEG and ECG) of the cell. There is feed back of these effects to higher center and thus these effects are triggered and regulated. Both the effects (metabolic and electrical) have there feed back not only to higher centers but also to highest centers via first transcription. So highest centers is well informed about all effects of the cell. Higher centers are not autonomous centers rather they are also under control of highest centers of the universe.

2.4 Body functions and their regulation by different centers

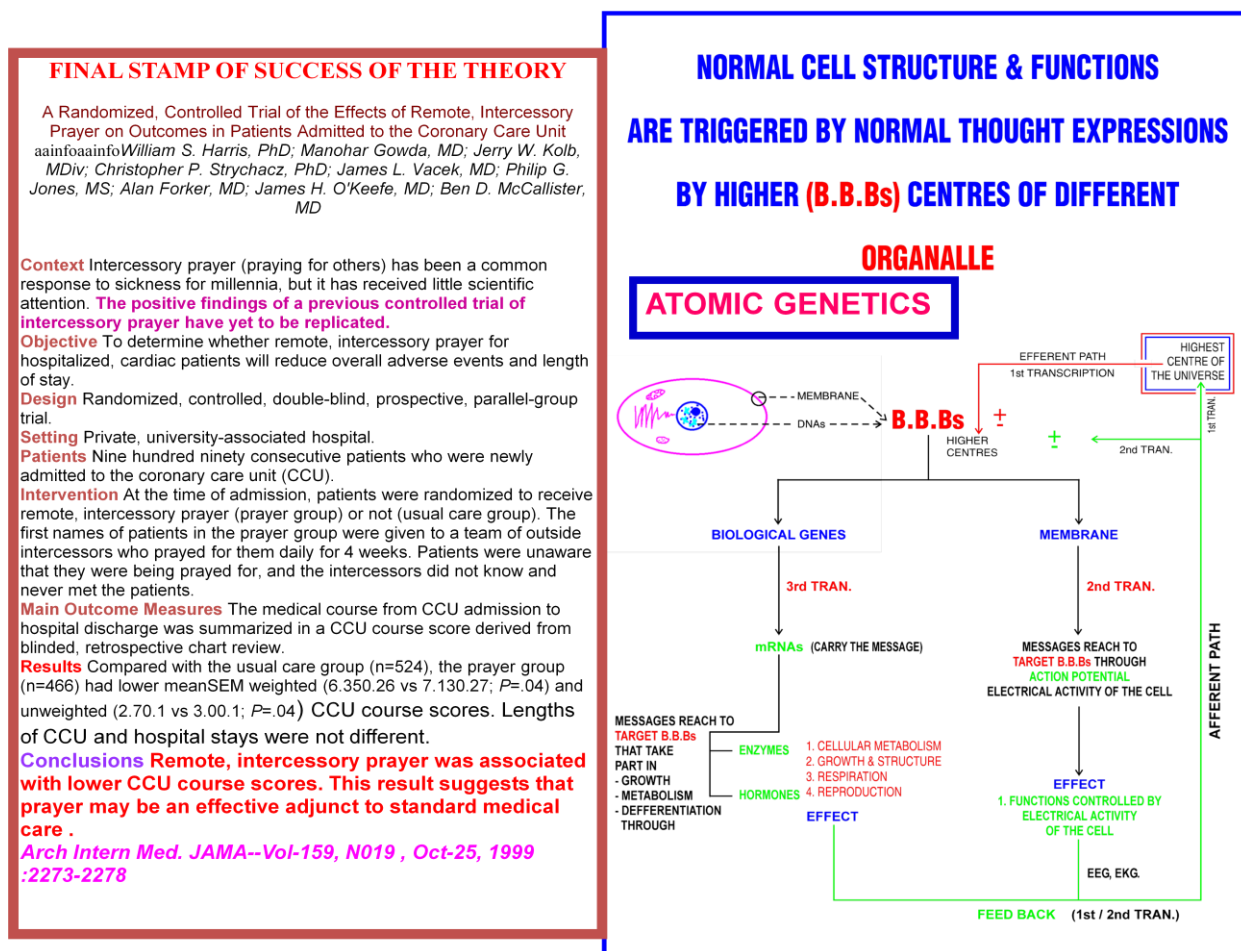

Fig 18 Stimulation of thought expression by unconditioned and conditioned

Our all body functions are triggered by different thoughts expressions by different higher centers present in biological genes or DNA or in membrane of the cell . Thus different life effects are seen . There is feed back to Highest center of the universe. That controls higher centers of our body. Prayer triggers this highest center to have its healing effect. Highest center is situated in invisible universe beyond CDM layer. Concept of SOUL is myth.

2.5 Conditioned stimulation of CCP phenomenon of Germination

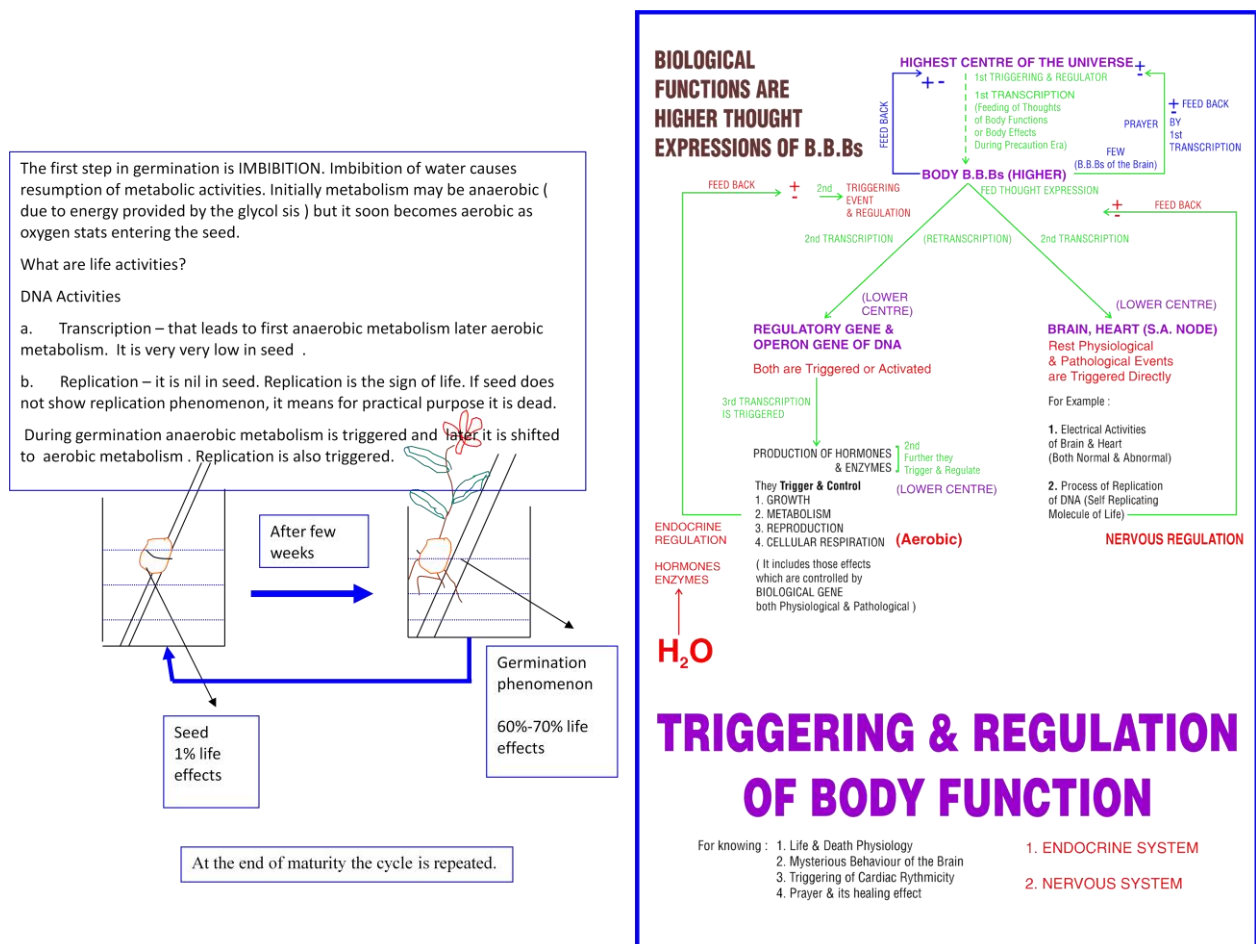

Fig19 Stimulation of thought expression by conditioned

Few functions are triggered by conditioned stimulation of thoughts like life and death physiology i.e. if you add water , you would see life effect and if you remove water , you would see death effect.

Seed is alive (say having 1% of life activity) but hardly show any sign of life. It has low water content and exhibits virtually no metabolic activity. Such quiescent seeds can live for many years but germinate when soaked in water under suitable temperature and in presence of oxygen. Metabolic activity (anaerobic)are very low in seeds. Metabolic activities come to visually standstill as the seed coat becomes increasable impermeable to oxygen and moisture.

The first step in germination is IMBIBITION. Imbibition of water causes resumption of metabolic activities. Initially metabolism may be anaerobic (due to energy provided by the glycol sis) but it soon becomes aerobic as oxygen stats entering the seed.

What are life activities?

DNA Activities

- Transcription – that leads to first anaerobic metabolism later aerobic metabolism. It is very very low in seed .
- Replication – it is nil in seed. Replication is the sign of life. If seed does not show replication phenomenon, it means for practical purpose it is dead.

During germination anaerobic metabolism is triggered and later it is shifted to aerobic metabolism . Replication is also triggered. The triggering of both the activities is onset of atomic transcriptions of replication as well as onset of transcriptions of aerobic metabolism. With the result messages come on the surfaces of DNAs and during 3rd transcriptions they are shifted to different mRNAs and finally they reach to different enzymes and hormones. These enzymes and hormones carry messages to target units . With the result we observe phenomenon of germination. The entire working has been depicted by line diagram (Fig –19). These atomic transcriptions are stimulated by water that is why it is **CONDITIONED STIMULATION of CCP**. The percentage of thought expressions increase with the time and we observe increase in the number of effects. At present we can say that plant is showing from 1 % to 20% or 40% of its effect till it reaches its maturity . At maturity the plant exhibits all effects and at that time we can say it is expressing 100% life atomic transcriptions. With the formation of new seed life atomic transcriptions once again reduced to 1% only. This cycle i.e. going from 1% life effects or atomic transcription to 100% life effects and coming back to 1% again is being visible to us at present. When water is withdrawn, it leads to suppression of life thought expressions and death thought expressions are triggered with the result we observe death effects of plant.

CONCLUSION OF THE EXPERIMENT- The phenomenon of life effect is triggered by atomic transcription of life. Unless life atomic transcriptions are triggered, life effects are not visible. So life effects are nothing but higher thought expressions of basic building blocks. Phenomenon of death is triggered by death atomic transcription. At the time of death life thought expressions are inhibited and death thought expressions are triggered with the result we observe death effects. Water only stimulates life thought expressions that leads to triggering of different life activities (metabolic , replication and other electrical activities) in side the cell.

Being a scientist, one must know how do life effects come about. Life effects are higher thought expressions of B.B.Bs. Formation of particles, atoms and molecules are due to lower thought expressions of B.B.Bs. But their higher thought expression lead to appearance of all life effects. One who knows properties of B.B.Bs. and atomic genetics, can understand how life effects are triggered. There is nothing like **SOUL**. **It is a myth** that when soul goes inside we get life and when it moves out we are dead. When thought expressions of life are suppressed and thought expressions, of death are triggered, we observe death effects. So life effects are basically triggered by atomic transcription occurring on B.B.Bs.

2.6 Laws on which atomic genes work.

Atomic Genetics and genetic damage as shown in figure -20

Having read **Atomic genetics and Basic etiology of the cancer**, now we discuss how atomic genetics trigger molecular effects like genetic damage etc during carcinogenesis. **ATOMIC GENETICS** is a new branch of science in which we study about **Laws, PROPERTIES and FUNCTIONS** of atomic genes. Now I shall highlight the laws on which atomic genes work. As we have seen that Gregor Mendel had made three laws of inheritance known as ---

1.The principle of Dominance---- Mendel therefore concluded that what were transmitted from parent to offspring were discrete factors. Each factor contained information about the form of the trait. The factor associated with the form which was expressed in the hybrid offspring (F1) was **DOMINANT**. For example, the factor for yellow seed color was a dominant factor. The factor associated with the form which remained hidden in the **F1** but reappeared in the **F2** was **RECESSIVE**. Thus the factor for the green seed color was recessive. Mendel's factor is now recognized as the gene. In atomic genetics this law is interpreted like this ---- During atomic transcription or thought expressions few thoughts are expressed and these are called dominating thoughts and rest thoughts which are not expressed are called recessive thoughts. Thus particles, atoms and molecules show only those properties which are triggered by dominating thought expressions. **During transmutation, dominating thoughts get recessive while recessive thoughts get dominant.** Single effect or property is triggered by single dominating thought expression or atomic transcription. **For example--** Normal genetic arrangements are triggered by normal arrangement genetic dominating thought expressions while genetic damage is triggered by abnormal arrangement genetic dominating thought expressions. Abnormal arrangement genetic thought expression is triggered by carcinogens only after normal arrangement genetic thought expressions get recessive. Or we can say normal genetic arrangement are triggered by normal arrangement genetic thought expressions and when carcinogens come in contact with the cell, they shift the thought expression from normal to abnormal genetic arrangement. With the result we observe genetic damage. Thus carcinogens suppress dominating normal arrangement genetic thoughts and they trigger abnormal arrangement recessive genetic thoughts. With the result genetic damage is seen.

2.The Principle of Segregation---The principle of segregation states that allele pairs separate or segregate during gamete formation, and the paired condition is restored by random fusion of gametes during fertilization. In atomic genetics it will be interpreted like this --- There is separate atomic transcription for separate effects. So if there are hundred effects, they all are triggered by hundred separate thought expressions or atomic transcriptions. For example --- Genetic damage is triggered by separate thought expression and rapid growth is triggered by separate thought expression and dedifferentiation is triggered by separate thought expression. And all these thought expressions are triggered by carcinogens. **But the timing of thought expressions is different.** Genetic damage thought expression is first to trigger and later rapid growth and dedifferentiation thought expressions.

3. The Principle of independent assortment---- The principle of independent assortment states that if we consider the inheritance of two or more genes at a time, their distribution in the gametes and in the progeny of subsequent generations is independent of each other.

In atomic genetics it will be interpreted like this--- In one phenomenon, if two or more than two transcriptions or thought expressions are expressed that will give rise to two or more than two effects, **it dose not mean that there expression is DEPENDENT ON EACH OTHER.**

For example --- In phenomenon of carcinogenesis, there is effect of genetic damage, there is effect of rapid growth and there is effect of dedifferentiation. All these effects are triggered by separate thought expressions. The simultaneous expression of these atomic transcriptions is independent of each other. Or these thoughts expressions are the part of the carcinogenesis phenomenon but their expressions are independent of one another. **It does mean that for rapid growth thought expression, genetic damage thought expression is NOT essential.** Having informed about the laws and working of atomic genes, Now we discuss phenomenon of carcinogenesis, which is triggered by, outer stimuli like physical, chemical carcinogens or virus or they are self stimulated i.e. hereditary factors.

When Genetic damage is not essential for cancer transmutation then what is the role of Genetic damage? . **Why do carcinogens trigger genetic damage first? How do carcinogens trigger carcinogenesis?**

PHENOMENON OF CELL TRANSMUTATION

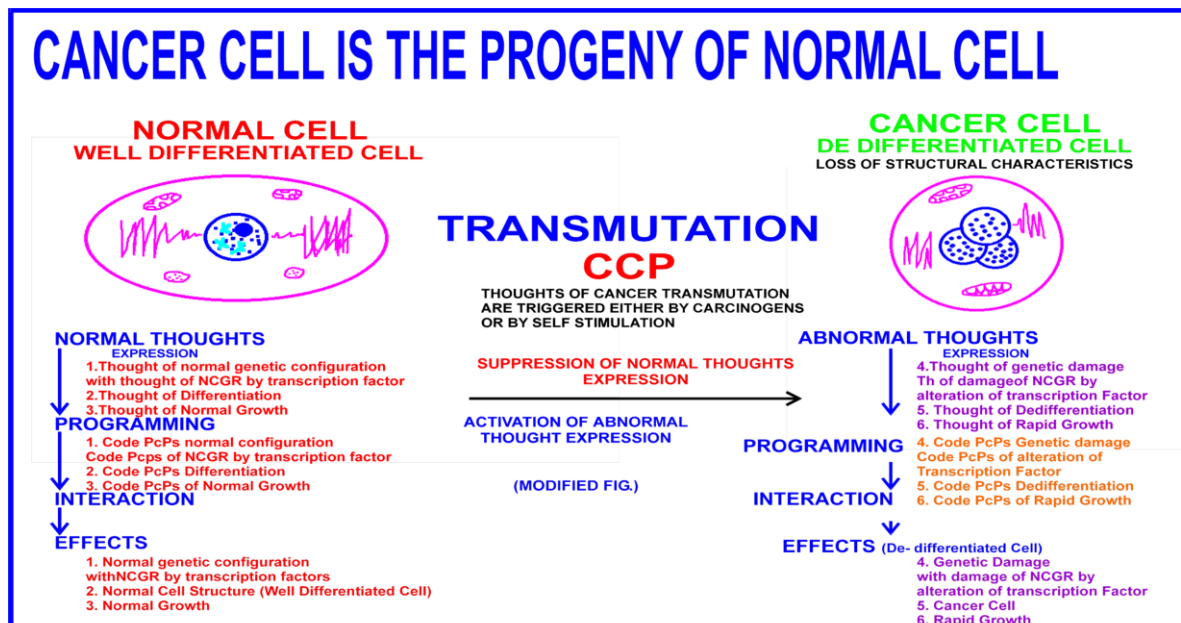

CAECINOGEN SENDS MESSAGE OF SHIFTING TO B.B.B OF PRO-ONCOGENS TO STOP 1ST NORMAL THOUGHTS AND TO TRIGGER 4TH ABNORMAL THOUGHTS (MESSAGE OF MUTATION) . LATER ONCOGENE B.B.B RECEIVES THE MESSAGES FROM CARCINOGEN B.B.B TO SHIFT 2ND AND 3RD THOUGHTS TO 5TH AND 6TH THOUGHTS EXPRESSIONS (MESSAGES OF CARCINOGENESIS OR MALIGNANT TRANSFORMATION) STEP BY STEP AND SEPARATLY. WITH THE RESULT ALL NORMAL CELL B.B.BS TRANSMUTATE INTO CANCER CELL B.B.BS WITH CHANGE OF THOUGHTS FROM NORMAL TO ABNORMAL

Fig 20 phenomenon of cell transmutation into cancer

STIMULATION OF THOUGHT EXPRESSION --- Shifting of thought expressions from normal to abnormal could be triggered by either from outer stimuli i.e. **CONDITIONED STIMULATION** of thought expression, which is caused by physical and chemical carcinogens or viruses etc or it is self stimulate i.e. **UNCONDITIONED STIMULATION** of thought expression , which is caused by hereditary factors.

2.7 Phenomenon of decay of particles

To understand laws of decay of subatomic particles , we should understand first **laws of transmutation** because decay is nothing but a process of transmutation. In biological world , we observe this phenomenon first to understand the process of decay.

1. Any transformation of animal protein into our body protein , it first breaks down in to its basic constituent or basic unit or more fundamental units which are known as amino acids. The number of amino acids absorbed in digestion before transformation are equal to number of amino acids after transformation of body protein . These transformations are taking place in presence of enzymes



Now the equation is balanced . This dark matter (2.99999 kg) is in form of food taken by mother during 9 months . That helps to make the baby of 3 kg. In this process of decay MIND is involved . Hence CCP is also written . Unless mind triggers , nature cannot decay or transform.

This is the philosophy of decay of every phenomenon in the universe

2.8 , 1 Stability and beta decay wrong depiction

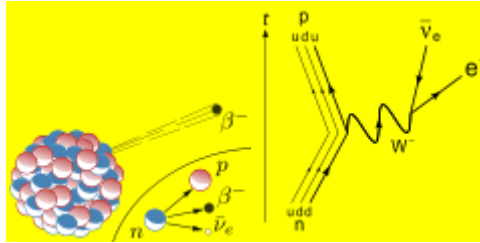

Fig 21 Beta decay -- wrong depiction

RIGHT DEPICTION

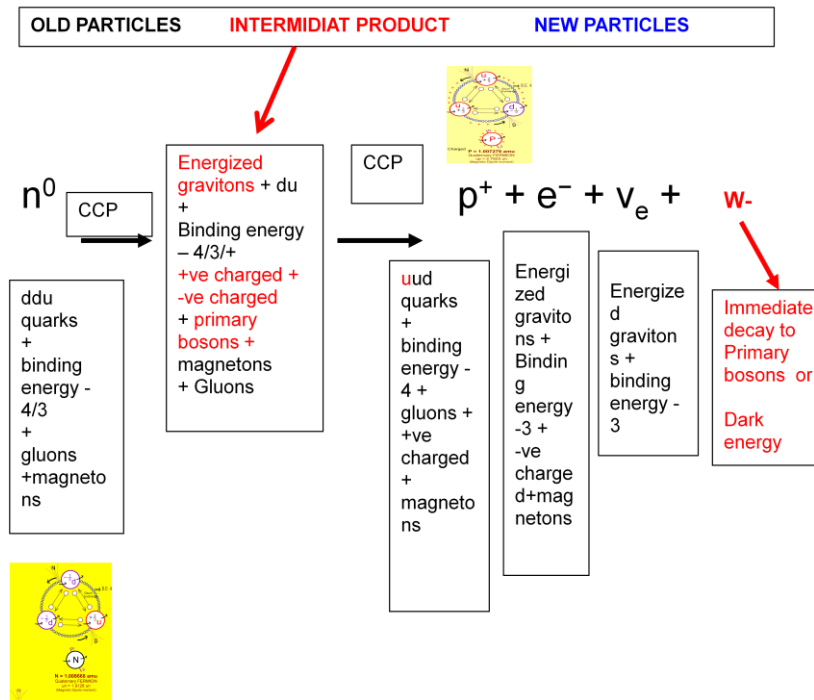

Fig 22 beta decay – Right Depiction

2. ANNIHILATION

a. WRONG DEPICTION

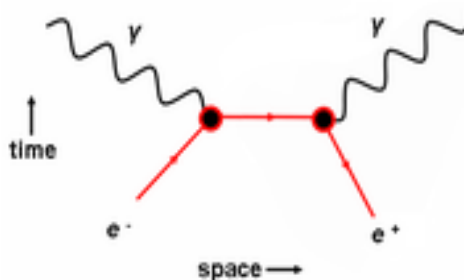

Fig 23 electron positron annihilation -- wrong depiction

RIGHT DEPICTION

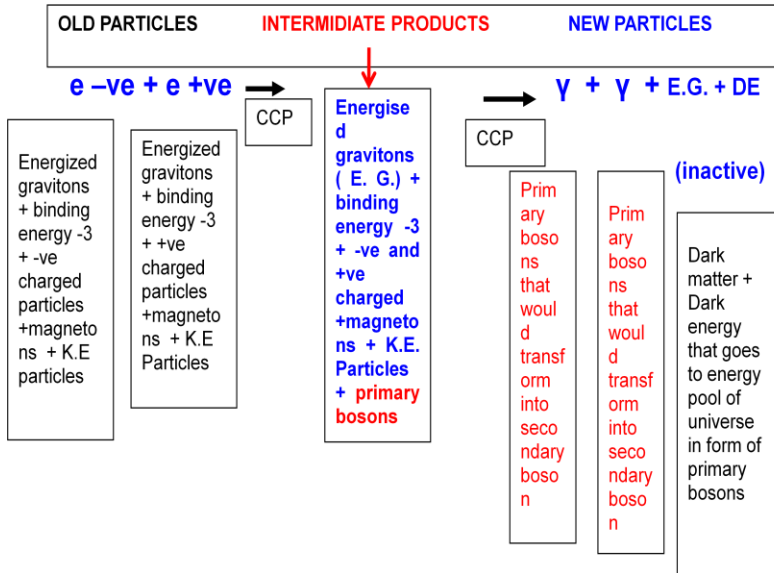

Fig 24 electron positron annihilation

Annihilation

b. Wrong Depiction

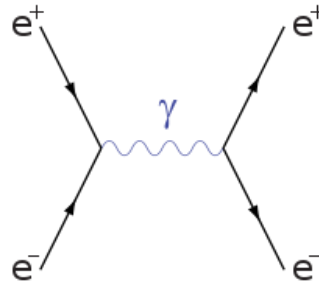

Fig 25 electron positron Annihilation -- wrong depiction

RIGHT DEPICTION

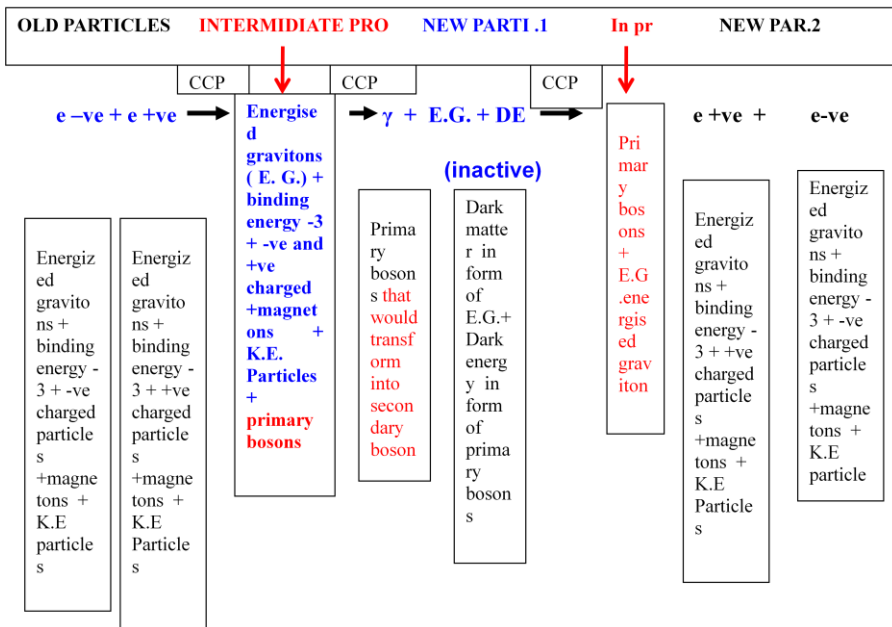
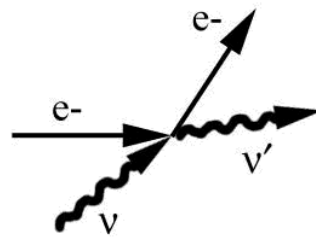

Fig26 electron positron Annihilation

3. Inverse Compton scattering
Wrong depiction

Inverse Compton scattering



$\nu' > \nu$
High energy e- initially
e- loses energy

Fig 27 Inverse Compton scattering --- wrong depiction

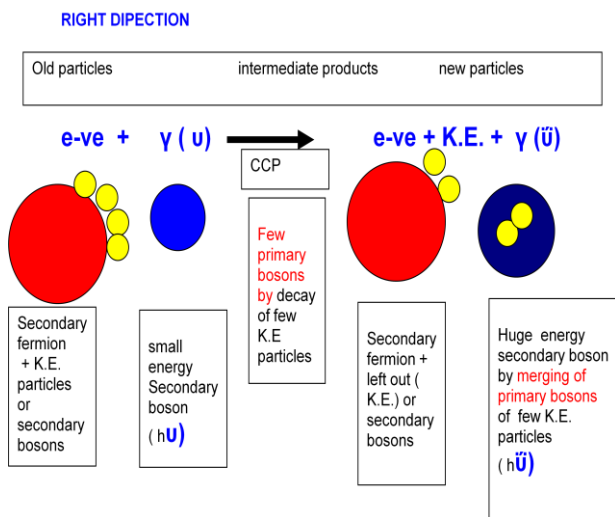
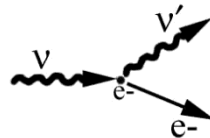

Fig 28 Inverse Compton scattering

4. COMPTON EFFECT
Wrong Depiction

Compton scattering



$\nu' < \nu$
Electron is initially at rest
e- gains energy

Fig 29 Compton effect -- wrong depiction

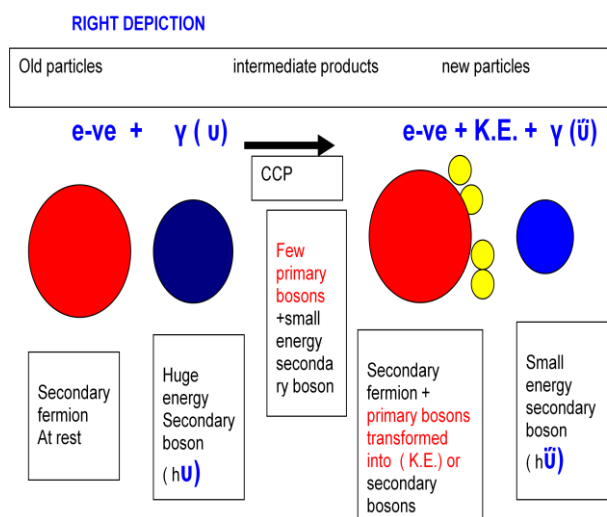

Fig- 29 Compton effect

To understand phenomenon of decay one must have full knowledge of structure of the matter up to the level of basic building blocks, with knowledge of MIND with knowledge to make the equation of decay balanced on right hand and left hand side in terms of **fundamental units** i.e. of which the older particles and new created particles are made up of and knowledge of dark matter and dark energy i.e. raw stuff that also take part in decay.

2.9 Water, Food and Energy cycle in Normal and Alternative Physiology and Ecology and phenomenon of Decay or transformation of Matter and Energy

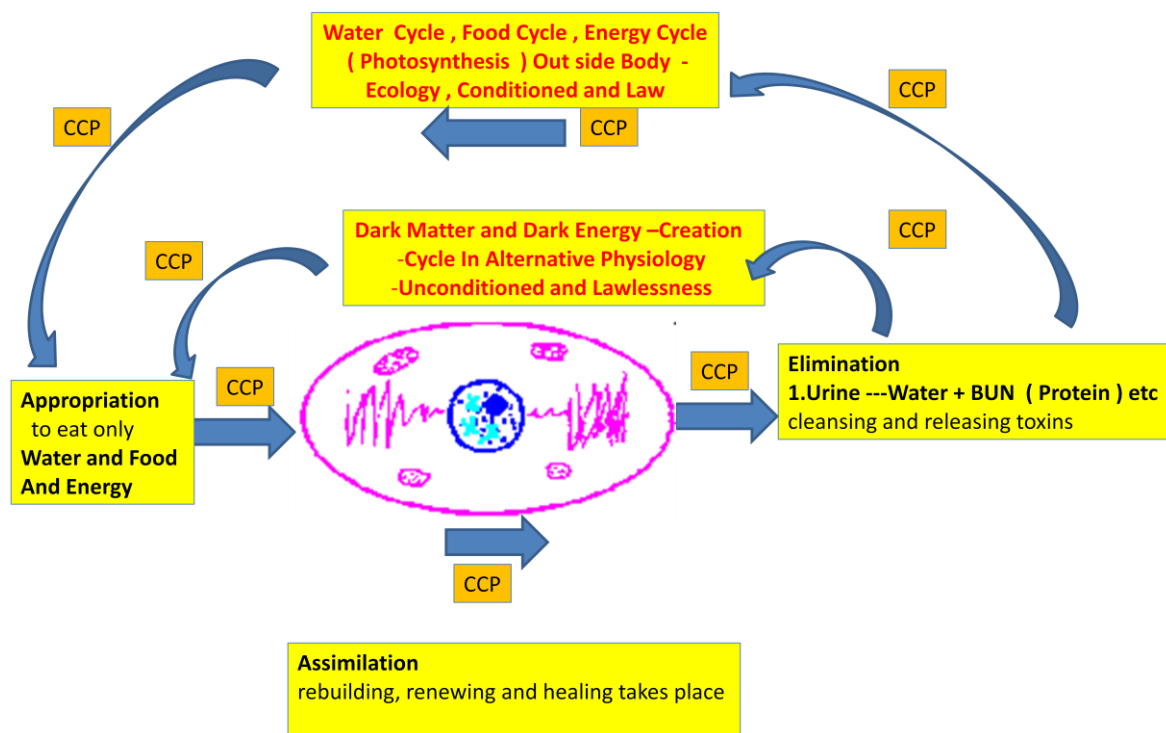

Fig-30 Water, Food and Energy cycle in Normal and Alternative Physiology and ecology and phenomenon of Decay or transformation of Matter and Energy

V. Conclusion

What are those abnormal water , food and energy cycle thoughts that triggered after the age 11 in Prahlad's body that led to transformation of body cells to live under starvation i.e. Weight loss and gain (38 to 42 kgs) , vanishing of urine in bladder in different sono graphy finding and no food in digestive systems despite of normal blood biochemistry , all suggest lawlessness due to unconditioned thought expressions by the higher center of the different organ of Prahalad's living Body . But thoughts that trigger aging by different cells are normal (childhood – adolescence , adult hood , old age) . There are many thoughts that trigger to maintain our

body structure and functions . But to understand the concept only few thoughts have been depicted in diagrams (Cancer diagram) . There is feedback to higher centers of cell before next thought is triggered . Our body cells (higher centers) are not autonomous center rather they are under control Highest center of the universe . At the time of death message (First order of universe – Quantum entanglement) comes from Highest of the universe to higher center (Say S.A.Node) of heart and B.B.B of S.A. Node stops expressing rhythmicity thought expression (SDD, Depolarization and Repolarization – life thoughts stop) and cell dies or body dies (Death thoughts are triggered) . How long Prahalad would live only Almighty B.B.B could tell .

Starvation is a conditioned phenomenon but despite of starvation if cell lives ,it is unconditioned phenomenon and it is lawlessness. To understand phenomenon of body structure and function (Both normal and abnormal) , we have to understand Basic Building Blocks (B.B.B – Mind – CCP , Code PcPs and CP and Mass -- Fig 1) . Life effects are higher thought expressions (activation different Code PcPs – informations) of B.B.Bs. Formations of molecules , atoms and particles are due to lower thought expressions (Thought - CCP – Programming – Code PcPs –Interaction – Effects) . If thought expressions are abnormal it called lawlessness in nature . After certain age (11 years) Prahlad's body transformed to certain changes that are abnormal to us . And it followed Mandel's law of Independent assortment also . These thoughts are fed thoughts and feeding was done in precreation era by the Highest center of the universe . We are set of informations (Code PcPs) . Informations (Code PcPs) never die . The theory predicts that Informations(Code PcPs) could be recreated . Hence dead cell could be made Alive only by Highest center of the universe (Almighty B.B.B)

To understand phenomenon of decay one must have full knowledge of structure of the matter up to the level of basic building blocks, with knowledge of MIND with knowledge to make the equation of decay balanced on right hand and left hand side in terms of **fundamental units** i.e. of which the older particles and new created particles are made up of and knowledge of dark matter and dark energy i.e. raw stuff that also take part in decay.

Acknowledgement



"Mataji" Prahlad Jani claims to have lived more than 70 years without eating and drinking. The Indian Yogi was tested twice in strictly controlled experiments by the Indian Ministry of Defence giving indications for a groundbreaking scientific sensation. And the findings were so incredible that some skeptics still cannot believe in a true case. Why ?



Thanks to Dr Sudhir Shah – Principal Investigator and Director of Neurosciences, Sterling Hospital. Ahmedabad, for conducting study . "We have to hypothesize alternative forms of energy. I am not looking at this one case. I am looking at the force behind that. And that is really going to change the future of mankind. I am pretty sure."

References

- [1] https://en.wikipedia.org/wiki/Prahlad_Jani
- [2] V M Das *International journal of innovative research and development* **Volume 3 Issue 8** p 194- 210 (2014)
- [3] M Das *International Journal of Sciences: Basic and Applied Research (IJSBAR)* **Volume 17, No 1**, p 292-324 (2014)
- [4] V M Das *International Journal of Sciences: Basic and Applied Research*, **Volume 17, No 1**, p 148-185 (2014)
- [5] V M Das *International Journal of Sciences: Basic and Applied Research*) **Volume 16, No 2**, p 274-309 (2014)
- [6] W S Harris *JAMA Arch Intern Med.* **Volume 159, N019** , Oct-25 p 2273-2278 (1999)
- [7] V M Das *International Journal of Sciences: Basic and Applied Research* **volume 16 , number 1** , p 311-338 (2014)
- [8] V M Das *Social and basic sciences and research review* **Volume 2**, Issue 4 p 197-255 (2014)
- [9] V.M.Das *Asian Journal of Science and Technology* **Vol.06 Issue 12**, pp.2075-2099 (2015)
- [10] V.M.Das *INTERNATIONAL JOURNAL OF SCIENTIFIC RESEARCH* **Volume 4 Issue 5** pp 795-804 (2015)
- [11] <https://www.youtube.com/watch?v=Fb3gn5GsvRk>

Dr V M Das . “Prahlad Jani Is A set Of Informations (Code PcPs) . Some Informations (Code PcPs -- water , food and energy cycle) Are Triggered By Unconditioned Thought Expressions (CCP) . Hence Few Body Metabolic Cycles (Water, Food And Energy) of Prahlad Are Showing Lawlessness . Mandel’s Law Of Independent Assortment States That Expression of Two or More Than Two Thoughts Are Independent of Each other.” IOSR Journal of Research & Method in Education (IOSR-JRME) , vol. 7, no. 5, 2017, pp. 55–87.